

**Pneumatic  
Pumps**



# AutoPump Automatic Air-Powered Pumps



Automatic air-powered pumps offer exceptional capabilities in the severe pumping conditions found at many landfill and remediation sites. QED's AutoPump® (U.S. Patent Number 5,004,405) pumps originated the automatic air-powered pump concept in 1986 and have lead the industry ever since. AutoPumps were designed specifically to handle difficult conditions reliably and safely, including, hydrocarbons landfill leachates and condensates, solvents, suspended solids, silts, corrosives, and high viscosities, along with high temperatures and frequent starts and stops. Air-powered AutoPumps are proven worldwide at thousands of sites, which is why AutoPumps are the No. 1 choice of professionals based on reliability, durability, performance range, and technical support.

The superiority of the AutoPump design is based on four key strengths:

- high clearance fluid pathways
- using air as the motive force
- materials of construction matched to site conditions
- a simple yet rugged operating mechanism

Unlike electric pumps, air-powered AutoPumps use no high-speed motors, bearings or impellers, so AutoPumps don't heat up, seize up, or get ground up. Liquid shearing is typical of electric pumps, creating oil-water emulsions that reduce the performance of downstream treatment equipment. AutoPumps cause far less liquid shearing than electric submersible pumps so downstream treatment systems can perform better. Air-powered also means eliminating the dangers and costs of electricity at and in the well. Finally, AutoPumps actually have a built-in control system – they pump when there is liquid present and shut down when the level is drawn down, without the need for any sensors in the well or controls at the surface.

## Application Excellence

Remediation applications and landfill fluids pumping are very challenging. QED is dedicated to providing a comprehensive approach to meeting the specific needs of each site and well, taking into account many factors beyond just flow rate and depth, such as:

- Preferred inlet position number – top or bottom
- Pump length to match water column and meet drawdown requirements
- A broad range of materials of construction to match fluid properties and temperature
- Jacketed tubing sets, bundled hose and quick-connect options to ease installation and service
- A wide variety of standard and custom wellhead completions to fit site needs

## Experience and Expertise

The AutoPump specialists at QED have unsurpassed experience in both typical and special applications, providing the quality and care that makes a difference. Call us at 1-800-624-2026 for prompt, professional assistance, or visit our web site at [www.qedenv.com](http://www.qedenv.com) to access product and application information.

How AutoPumps Work	2	▼ QED
Why AutoPumps Are Better	3	
Guide to AutoPumps Selection	4	
Complete Systems	5	
Long AP4 Ultra Bottom Inlet Pump	6 – 9	
Short AP4 Ultra Bottom Inlet Pump	10 – 13	
Long AP4 Ultra Top Inlet Pump	14 – 17	
Short AP4 Ultra Top Inlet Pump	18 – 21	
Long AP4+ Bottom Inlet Pump	22 – 25	
Short AP4+ Bottom Inlet Pump	26 – 29	
Low-Drawdown AP4+ Bottom Inlet Pump	30 – 33	
Long AP4+ Top Inlet Pump	34 – 37	
Short AP4+ Top Inlet Pump	38 – 41	
Low-Drawdown AP4+ Top Inlet Pump	42 – 45	
Long AP3 Bottom Inlet Pump	46 – 49	
Short AP3 Bottom Inlet Pump	50 – 53	
Long AP3 Top Inlet Pump	54 – 57	
Short AP3 Top Inlet Pump	58 – 61	
Long AP2 Bottom Inlet Pump	62 – 65	
Short AP2 Bottom Inlet Pump	66 – 69	
Long AP2 Top Inlet Pump	70 – 73	
Short AP2 Top Inlet Pump	74 – 77	
Tubing and Hose	78	
Well Caps	79	
Flow Counters	80	
Air Supply	81	
Tank-Full Shutoff	82	
Application Data Sheet	83	
Warranty	Inside Back Cover	



# How AutoPumps Work

## Fill Cycle

The fluid pushes the inlet check valve open and fluid enters the pump.

As the fluid level rises, air is expelled through the exhaust air valve and the internal float rises to the top of its stroke.

In this upper position, the float triggers a lever assembly, which closes the air exhaust valve and opens the air inlet allowing air to enter and pressurize the pump.

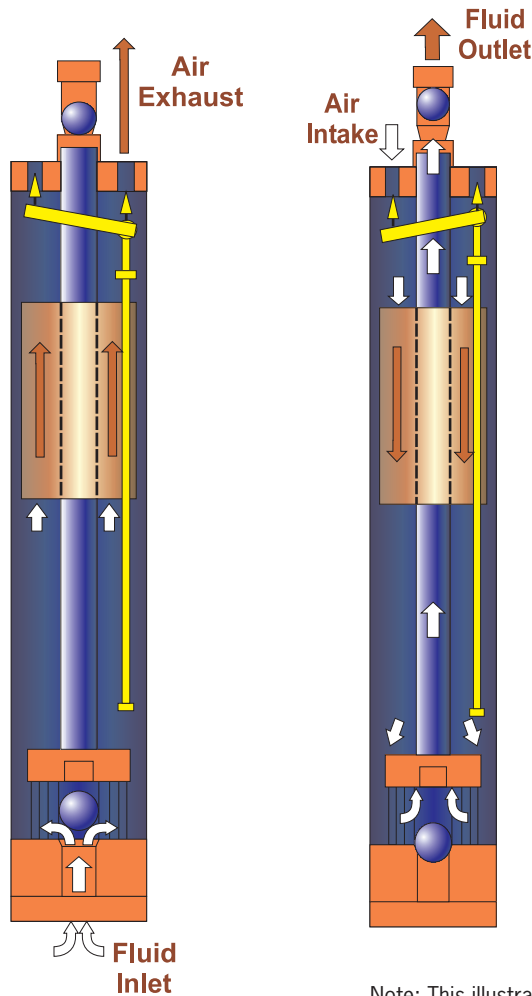

## Discharge Cycle

With the air inlet open, air pressure builds up within the pump body. This causes the fluid inlet check valve to close and forces the fluid to be displaced up and out of the fluid outlet.

As the fluid level falls, the float moves downward to the bottom of its stroke.

In this lower position, the float triggers the lever assembly to close the air supply and open the air exhaust valve, and a new cycle begins.

Note: This illustration is for a bottom filling format. A top loader is also available with both the inlet and discharge at the top of the pump.

## AutoPump Reliability

The AutoPump® air-powered pump operating cycle diagrams and explanation above tell just part of the story of AutoPump technology. Engineering an automatic pump to function in clear water is just the start. The real secrets of AutoPump durability and reliability are based on over 18 years of site experience in difficult pumping applications. AutoPumps are designed to resist chemical attack, abrasive wear, mechanical wear, solids deposits, viscous fluids and elevated temperatures. The entire air valve control mechanism has been refined in many subtle ways to survive these severe pumping conditions, using special materials, tolerances, and safety factors to provide years of trouble-free cycling. And, now there is the new AutoPump AP4 Ultra, which uses proprietary non-stick finishes on the float and discharge tube to help reduce solid buildups, extending the time between cleaning and making it much faster and easier to clean the pump. AutoPumps are the first of their kind, first in design experience, and first in reliability and durability.

# Why AutoPumps Are Better

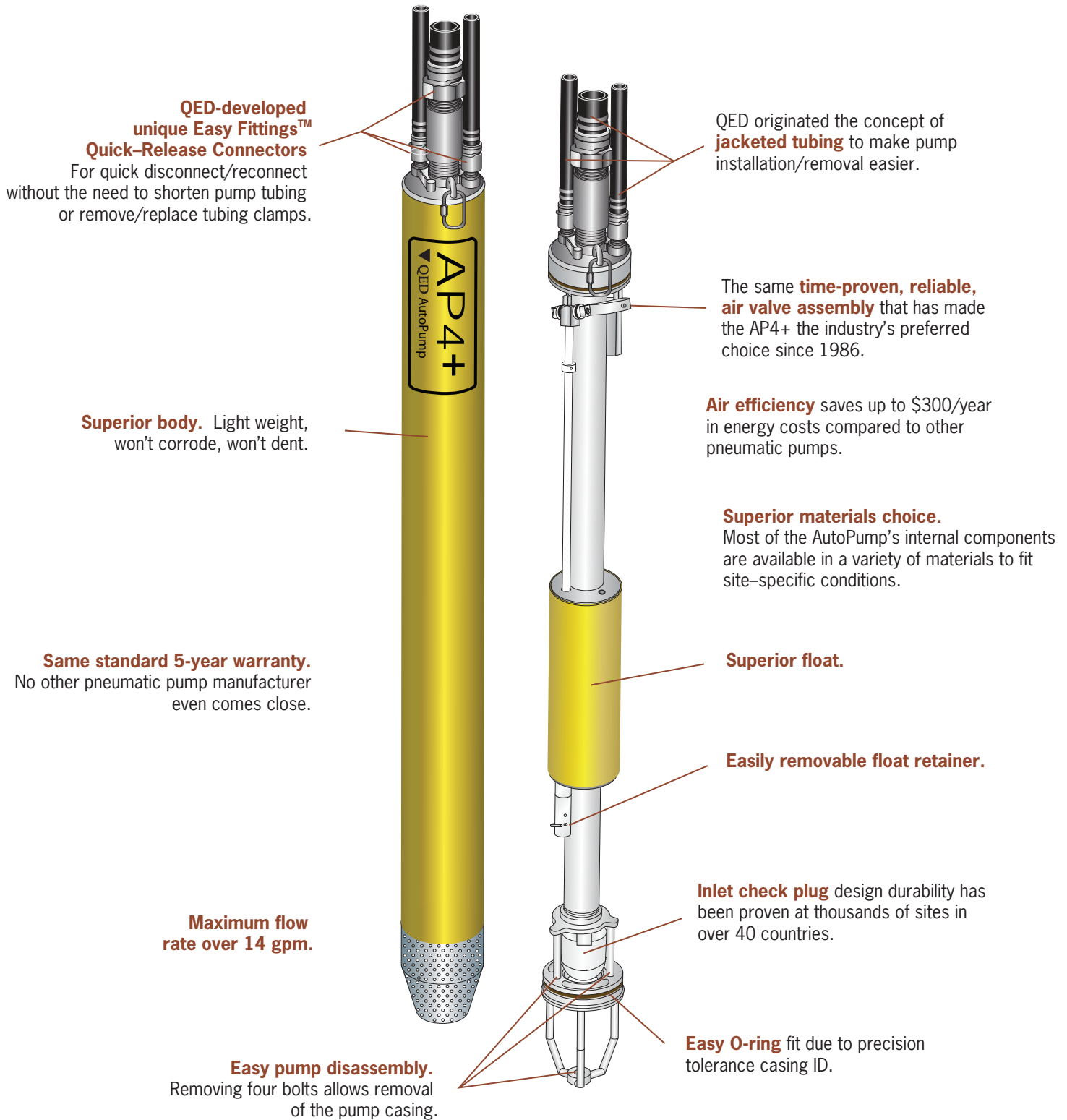

# Guide to AutoPump Selection

## Quick Guide to AutoPump Selection

An important advantage of an AutoPump® (U.S. Patent Number 5,004,405) air-powered Pump system is the wide range of choices to truly match site needs. Below is a quick guide to the major configurations and options offered in the AutoPump line, to help you determine which models are best for your project. Of course, you can just call us at 1-800-624-2026, or email us at info@qedenv.com, for fast, personal service by our application specialists.

As a general guideline, pump model selection is usually based on the following primary application criteria. They are presented in the common sequence of consideration, but special site needs may alter the priority.

- **Maximum Flow and Depth** – pump model, depth, submergence, and drive pressure determine the maximum flow rate that can be achieved; see specific pump curves for detailed flow information
- **Pump Diameter** – to fit the well ID; also, larger diameter pumps deliver higher flow rates, all other factors being equal
- **Inlet Position** – top or bottom inlet; a top inlet enhances removal of LNAPLs, while bottom inlets provide the highest flow rates and greatest solids-handling capacity for DNAPL, and landfill fluids
- **Actuation Level** – minimum height of liquid needed to actuate the pump, also equal to the minimum drawdown level; low-drawdown models are optimized for maximum drawdown
- **Materials of Construction** – many models are available in upgraded materials for special applications, such as extremes of pH, suspended solids, high temperatures, and aggressive solvents. The new low-maintenance AutoPump AP4 Ultra uses special non-stick finishes on the float and discharge tube. All metallic parts are 316-grade stainless steel, allowing for greater corrosion resistance.

AutoPumps	Model	Pg#	Inlet Position	Out. Diameter in./cm	Overall Length in./cm	Max. Flow gpm/Lpm	Max. Depth ft./cm	Act. Level in./cm
<b>4" Bottom Inlet AP Pumps</b>								
Long AP4 Ultra Bottom Inlet	Long AP4.0B	07	Bottom	3.6 / 9.1	51.4 / 131	14 / 53	250 / 76	38.4 / 98
Short AP4 Ultra Bottom Inlet	Short AP4.0B	10	Bottom	3.6 / 9.1	39.3 / 100	13 / 49	425 / 130	26.7 / 68
Long AP4+ Bottom Inlet	Long AP4+B	22	Bottom	3.6 / 9.1	51.4 / 131	14 / 53	250 / 76 <sup>2</sup>	38.4 / 98
Short AP4+ Bottom Inlet	Short AP4+B	26	Bottom	3.6 / 9.1	39.3 / 100	13 / 49	250 / 76 <sup>2</sup>	26.7 / 68
Low-Drawdown AP4+ Bottom Inlet	LD AP4+B	30	Bottom	3.6 / 9.1	27.5 / 70	7 / 26.5	250 / 76	15.3 / 39
<b>4" Top Inlet AP Pumps</b>								
Long AP4 Ultra Top Inlet	Long AP4.0T	16	Top	3.6 / 9.1	56.7 / 144	10 / 38	250 / 76	53.3 / 135
Short AP4 Ultra Top Inlet	Short AP4.0T	18	Top	3.6 / 9.1	45 / 110	9 / 34	250 / 76	41.6 / 106
Long AP4+ Top Inlet	Long AP4+T	34	Top	3.6 / 9.1	56.7 / 144	10 / 38	250 / 76 <sup>2</sup>	53.3 / 135
Short AP4+ Top Inlet	Short AP4+T	38	Top	3.6 / 9.1	45 / 110	9 / 34	250 / 76 <sup>2</sup>	41.6 / 106
Low-Drawdown AP4+ Top Inlet	LD AP4+T	42	Top	3.6 / 9.1	30.75 / 78	6.4 / 24	250 / 76	27.4 / 70
<b>3" Bottom Inlet AP Pumps</b>								
Long AP3 Bottom Inlet	Long AP3B	46	Bottom	2.63 / 6.68	52 / 132	7.3 / 27.6	220 / 67	31 / 79
Short AP3-Bottom Inlet	Short AP3B	50	Bottom	2.63 / 6.68	42 / 107	6 / 22.7	175 / 53.3	22 / 56
<b>3" Top Inlet AP Pumps</b>								
Long AP3-Top Inlet	Long AP3T	54	Top	3.4 / 8.64 <sup>3</sup>	57 / 145	5.4 / 20	220 / 67	53 / 135
Short AP3 Top Inlet	Short AP3T	58	Top	3.4 / 8.64 <sup>3</sup>	47 / 119	4.8 / 18.1	175 / 53.3	42 / 107
<b>2" Bottom Inlet AP Pumps</b>								
Long AP2 Bottom Inlet	Long AP2B	62	Bottom	1.75 / 4.45	55 / 139	2.3 / 8.82	300 / 91.4	35 / 89
Short AP2 Bottom Inlet	Short AP2B	66	Bottom	1.75 / 4.45	33 / 85	2 / 7.57	300 / 91.4	20 / 51
<b>2" Top Inlet AP Pumps</b>								
Long AP2-Top Inlet	Long AP2T	70	Top	1.75 / 4.45	57 / 144	1.9 / 7.2	300 / 91.4	52 / 132
Short AP2-Top Inlet	Short AP2T	74	Top	1.75 / 4.45	35 / 89	1.6 / 6.0	300 / 91.4	31 / 78

<sup>1</sup> Consult QED for higher flow requirements

<sup>2</sup> High Pressure Option for 4" AP pumps

<sup>3</sup> Optional 2.63" (6.68cm) OD available

# Complete Systems

Complete AutoPump® systems offer the greatest assurance of a smooth installation, dependable performance and easy maintenance. Common system components include:

- In-well hose and tubing – see page 78
- Wellhead completion caps and flanges – see page 79
- Cycle counters – see page 80
- Air system filter/regulators – see page 81

Call 1-800-624-2026 or visit [www.qedenv.com](http://www.qedenv.com) for prompt assistance with all of the above.

## Basic Pump Systems

### Basic System Bottom Inlet Pump

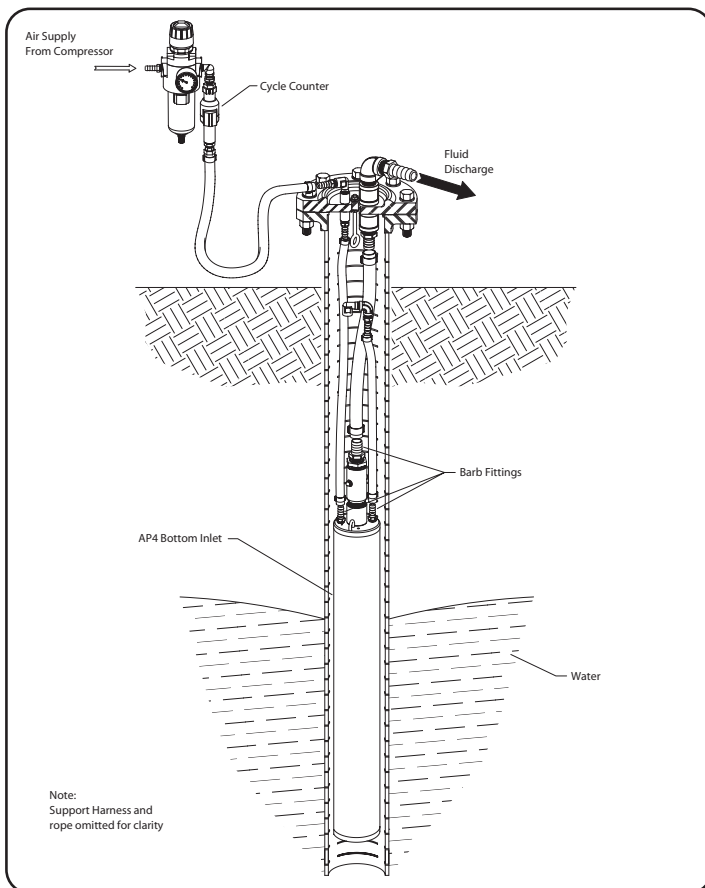

### Basic System Top Inlet Pump

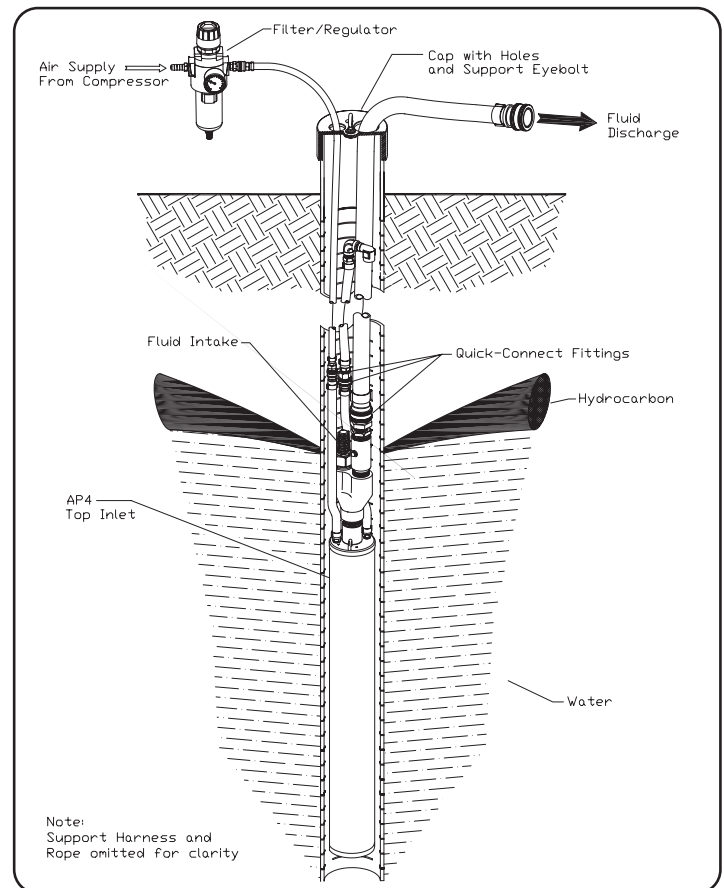

# AP4.0B

# AutoPump® AP4 Ultra

## Bottom Inlet, Long

**Max. Flow** 14 gpm (53 lpm)\*

**O.D.** 3.6 in. (9.1 cm)

**Length** 51.4 in. (131 cm)



### Description

The AutoPump AP4 Ultra Bottom Inlet Long provides maximum capabilities and flow in a bottom inlet pump for 4" (100 mm) diameter and larger wells. The base model delivers flow rates up to 14 gpm (53 lpm)\*. The AP4 Ultra uses proprietary non-stick finishes on the float and discharge tube to reduce solids buildup, extending the time between cleaning and making it much faster and easier to clean the pump. All metallic parts are 316-grade Stainless Steel, which has greater corrosion resistance and can withstand attacks of the harshest leachate. The AP4.0 Bottom Inlet Long pump is complemented by the most comprehensive selection of accessories to provide a complete system to meet site-specific requirements. Call QED for prompt, no-obligation assistance on your pumping project needs.

### The AutoPump Heritage

The AutoPump AP4 Ultra Bottom Inlet Long is part of the famous AutoPump family of original automatic air-powered pumps, developed in the mid 1980s specifically to handle unique pumping needs at remediation and landfill sites. Over the years they've proven their durability at thousands of sites worldwide. AutoPumps are designed to handle difficult pumping challenges that other pumps can't, such as hydrocarbons, solvents, suspended solids, corrosives, temperature extremes, viscous fluids and frequent start/stop cycles. Beyond just the pump, AutoPump systems offer the most complete range of tubing, hose, connectors, wellhead caps and accessories to help your installation go smoothly. This superior pumping heritage, application experience and support back up every AutoPump you put to work on your project.

### Advantages

1. The original automatic air-powered well pump, proven worldwide over 30 years.
2. Proprietary finishes extend the time between cleaning.
3. All metallic parts are 316-grade SS for better corrosion resistance.
4. New and improved valve stem connections have no fasteners, or cotter pins. Exhaust seat is easy to adjust.
5. Five-year warranty.

\*Consult QED for higher flow requirements



### Pump Dimensions

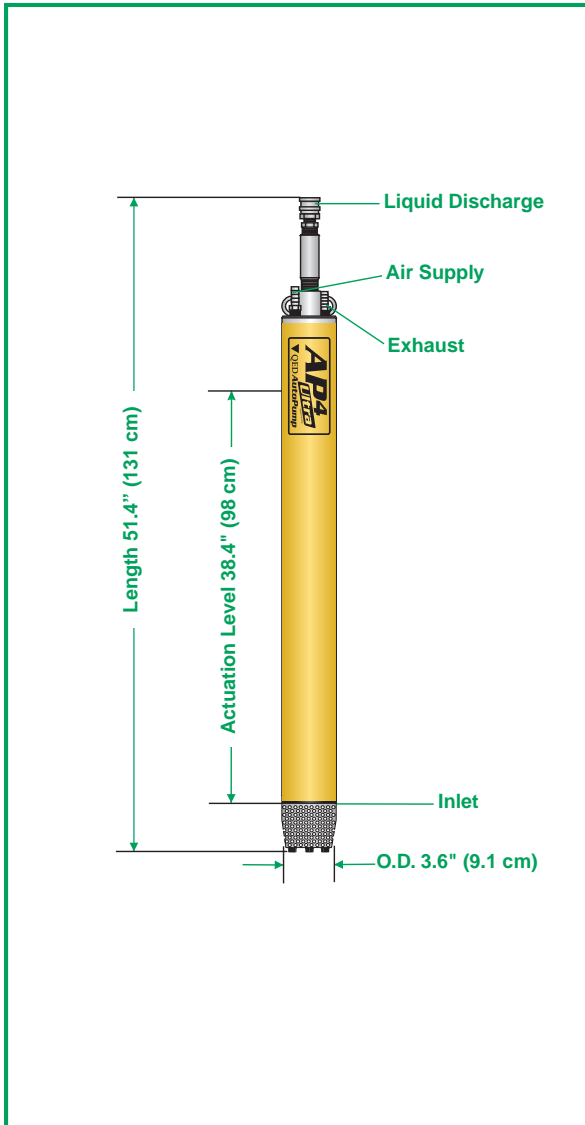

### Specifications & Operating Requirements

<b>Model</b>	<b>4" - Long AP4 Ultra Bottom Inlet</b>
<b>Liquid Inlet Location</b>	Bottom
<b>OD</b>	3.6 in. (9.1 cm)
<b>Length Overall (pump &amp; fittings)</b>	51.4 in. (131 cm)
<b>Weight</b>	16 lbs. (7.3 kg)
<b>Max. Flow Rate</b>	14 gpm (53 lpm) - See Flow Rate Chart*
<b>Pump Volume / Cycle</b>	0.58 - 0.78 gal. (2.2 - 3.0L)
<b>Min. Actuation Level</b>	38.4 in. (98 cm)
<b>Standard Pump</b>	
<b>Max. Depth</b>	250 ft. (76 m)
<b>Air Pressure Range</b>	5 - 120 psi (0.4 - 8.4 kg/cm <sup>2</sup> )
<b>Air Usage</b>	0.4-1.1 scf / gal. (3.0-8.5 liters of air / fluid liter) - See Air Usage Chart
<b>High Pressure Pump</b>	
<b>Max. Depth</b>	425 ft. (130 m)
<b>Air Pressure Range</b>	5 - 200 psi (0.4 - 14.1 kg/cm <sup>2</sup> )
<b>Min. Liquid Density</b>	0.7 SpG (0.7 g/cm <sup>3</sup> )
<b>Standard Construction Materials<sup>1</sup></b>	
<b>Pump Body</b>	Fiberglass or Stainless Steel
<b>Pump Ends</b>	316 Stainless Steel
<b>Internal Components</b>	316 Stainless Steel, Viton, PVDF <sup>3</sup>
<b>Tube &amp; Hose Fittings</b>	316 Stainless Steel
<b>Fitting Type</b>	Barbs or Quick Connects or Easy Fittings
<b>Tube &amp; Hose Options</b>	
<b>Tubing Material<sup>2</sup></b>	Nylon
<b>Sizes - Liquid Discharge</b>	1 in. (25 mm) or 1-1/4 in. (32 mm) OD
<b>Pump Air Supply</b>	1/2 in. (13 mm) OD
<b>Air Exhaust</b>	5/8 in. (16 mm) OD
<b>Hose Material</b>	Nitrile
<b>Sizes - Liquid Discharge</b>	3/4 in. (19 mm) or 1 in. (25 mm) ID
<b>Pump Air Supply</b>	3/8 in. (9.5 mm) ID
<b>Air Exhaust</b>	1/2 in. (13 mm) ID

<sup>1</sup> Material upgrades available  
<sup>2</sup> Applies to QED supplied tubing;  
 other tubing sources may not  
 conform to QED fittings.

<sup>3</sup> PVDF - Polyvinylidene Fluoride

### Application Limits (Base model)

AutoPump AP4 Ultra pumps are designed to handle the application ranges described below. For applications outside these ranges, consult QED about AP4 upgrades.

AutoPump AP4 Ultra Long and Short pumps are warranted for five (5) years: 100% materials and workmanship.

\*Consult QED for higher flow requirements

### Flow Rates<sup>1</sup>

**3/4 inch (19 mm)  
Inside Diameter Discharge Hose  
(Equivalent to 1-Inch O.D. Tubing)**

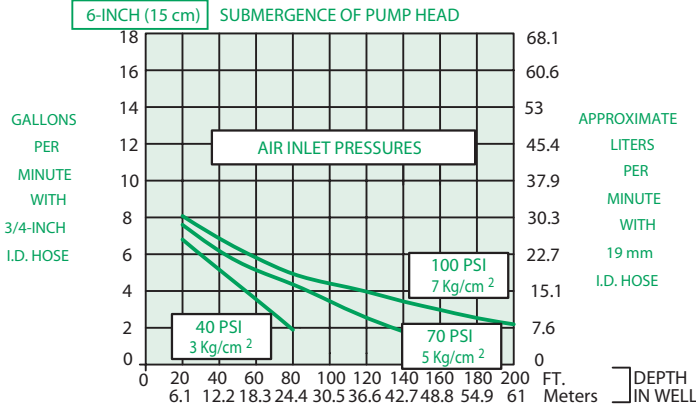

**1 inch (25.4 mm)  
Inside Diameter Discharge Hose  
(Equivalent to 1.25-Inch O.D. Tubing)**

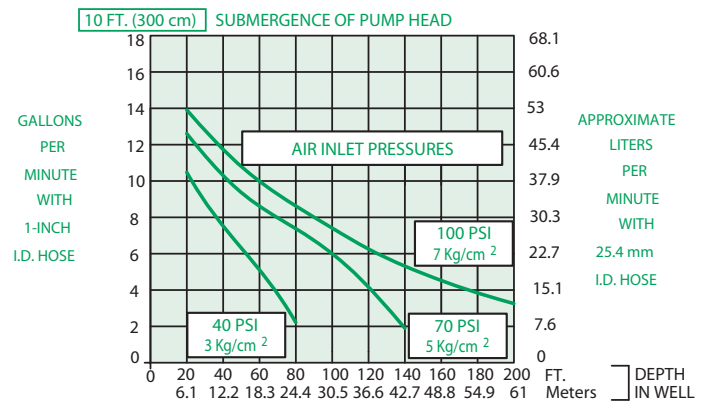
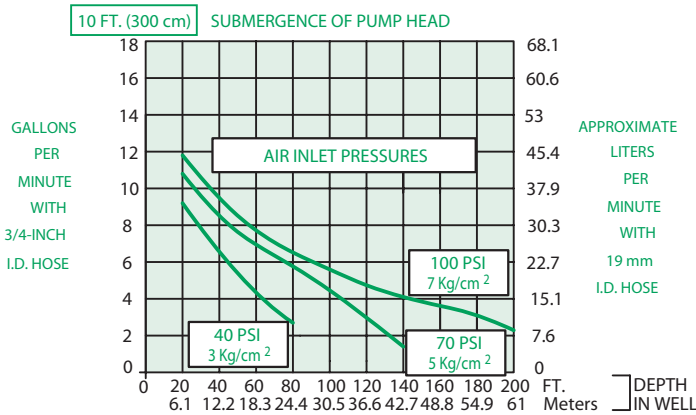
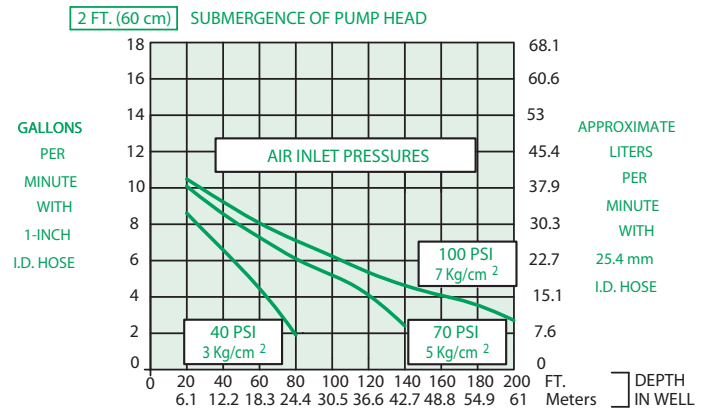
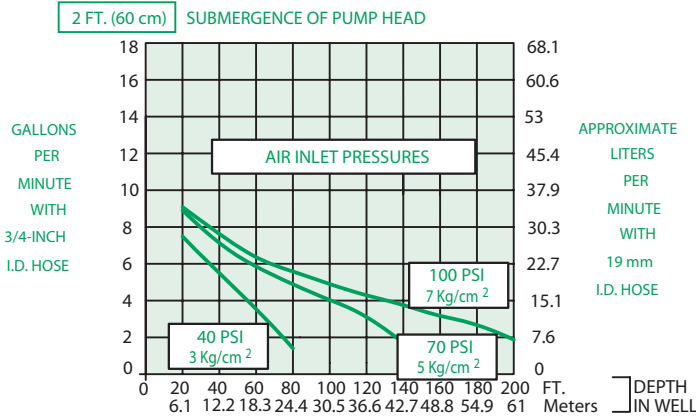
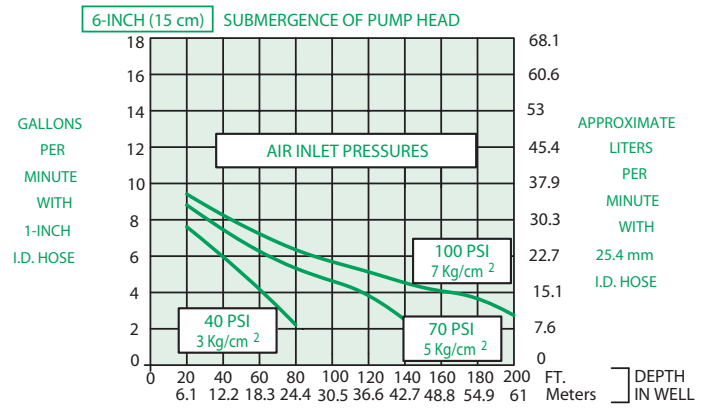

<sup>1</sup>FLOW RATES MAY VARY WITH SITE CONDITIONS. CALL QED FOR TECHNICAL ASSISTANCE.



### Air Consumption

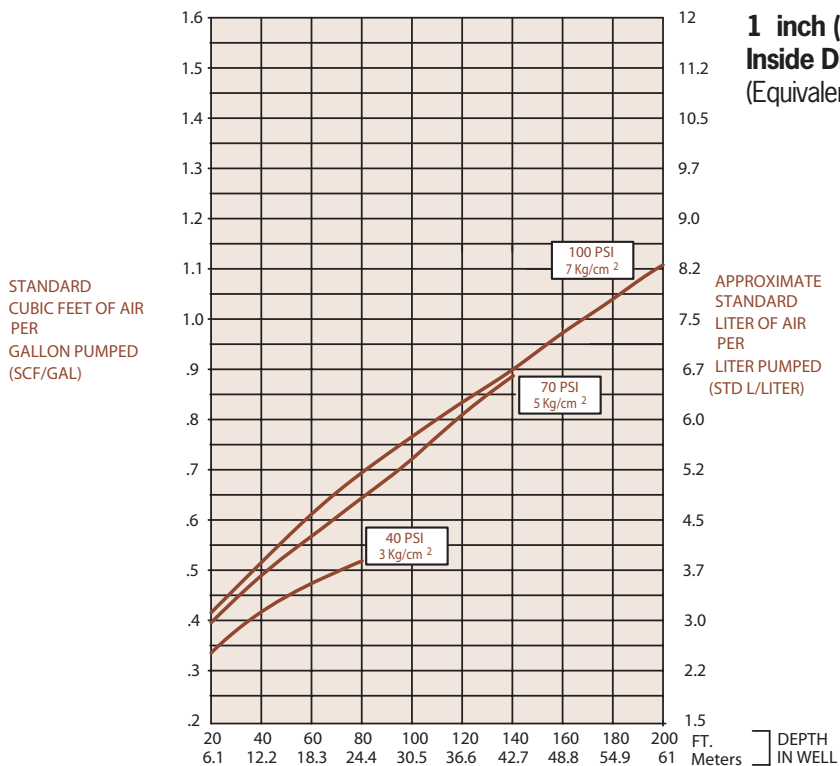
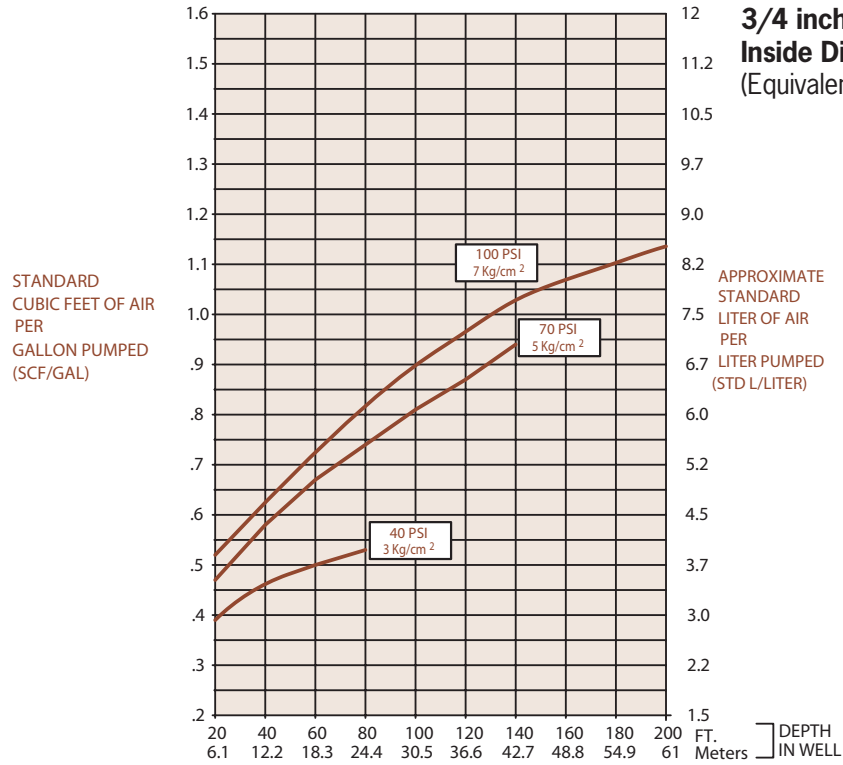

# AP4.0B

# AutoPump® AP4 Ultra

## Bottom Inlet, Short

**Max. Flow** 13 gpm (49 lpm)

**O.D.** 3.6 in. (9.1 cm)

**Length** 39.3 in. (100 cm)



### Description

The AutoPump® AP4 Ultra Bottom Inlet Short provides maximum capabilities and flow in a bottom inlet pump for 4" (100 mm) diameter and larger wells with shorter water columns and/or the need to pump down to lower water levels, compared to full-length pumps, and it can deliver flow rates up to 13 gpm (49 lpm)\*. The AP4 Ultra uses proprietary non-stick finishes on the float and discharge tube to reduce solids buildup, extending the time between cleaning and making it much faster and easier to clean the pump. All metallic parts are 316-grade Stainless Steel, which has greater corrosion resistance and can withstand attacks of the harshest leachate. The AP4.0 Bottom Inlet Short pump is complemented by the most comprehensive selection of accessories to provide a complete system to meet site-specific requirements. Call QED for prompt, no-obligation assistance on your pumping project needs.

### The AutoPump Heritage

The AutoPump AP4 Ultra Bottom Inlet Short is part of the famous AutoPump family of original automatic air-powered pumps, developed in the mid 1980s specifically to handle unique pumping needs at remediation and landfill sites. Over the years they've proven their durability at thousands of sites worldwide. AutoPumps are designed to handle difficult pumping challenges that other pumps can't, such as hydrocarbons, solvents, suspended solids, corrosives, temperature extremes, viscous fluids and frequent start/stop cycles. Beyond just the pump, AutoPump systems offer the most complete range of tubing, hose, connectors, wellhead caps and accessories to help your installation go smoothly. This superior pumping heritage, application experience and support back up every AutoPump you put to work on your project.

### Advantages

1. The original automatic air-powered well pump, proven worldwide over 30 years.
2. Proprietary finishes extend the time between cleaning.
3. All metallic parts are 316-grade SS for better corrosion resistance.
4. New and improved valve stem connections have no fasteners, or cotter pins. Exhaust seat is easy to adjust.
5. Five-year warranty.

\*Consult QED for higher flow requirements

### Pump Dimensions

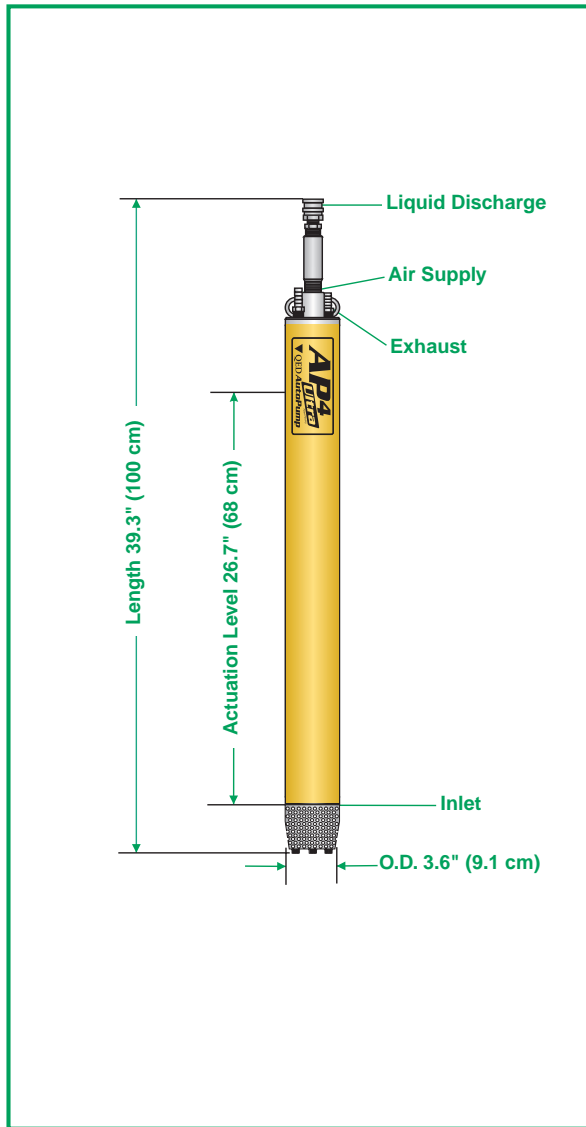

### Specifications & Operating Requirements

<b>Model</b>	<b>4" - Short AP4 Ultra Bottom Inlet</b>
<b>Liquid Inlet Location</b>	Bottom
<b>OD</b>	3.6 in. (9.1 cm)
<b>Length Overall (pump &amp; fittings)</b>	39.3 in. (100 cm)
<b>Weight</b>	13 lbs. (5.9 kg)
<b>Max. Flow Rate</b>	13 gpm (49 lpm)* - See Flow Rate Chart
<b>Pump Volume / Cycle</b>	0.22 - 0.36 gal (.83 - 1.36L)
<b>Min. Actuation Level</b>	26.7 in. (68 cm)
<b>Standard Pump</b>	
<b>Max. Depth</b>	250 ft. (76 m)
<b>Air Pressure Range</b>	5 - 120 psi (0.4 - 8.4 kg/cm <sup>2</sup> )
<b>Air Usage</b>	0.4-1.5 scf / gal. (1.5 - 5.7 liters of air / fluid liter) - See Air Usage Chart
<b>High Pressure Pump</b>	
<b>Max. Depth</b>	425 ft. (130 m)
<b>Air Pressure Range</b>	5 - 200 psi (0.4 - 14.1 kg/cm <sup>2</sup> )
<b>Min. Liquid Density</b>	0.7 SpG (0.7 g/cm <sup>3</sup> )
<b>Standard Construction Materials</b>	
<b>Pump Body</b>	Fiberglass or Stainless Steel
<b>Pump Ends</b>	316 Stainless Steel
<b>Internal Components</b>	316 Stainless Steel, Viton, PVDF <sup>3</sup>
<b>Tube &amp; Hose Fittings</b>	316 Stainless Steel
<b>Fitting Type</b>	Barbs or Quick Connects or Easy Fittings
<b>Tube &amp; Hose Options</b>	
<b>Tubing Material<sup>2</sup></b>	Nylon
<b>Sizes - Liquid Discharge</b>	1 in. (25 mm) or 1-1/4 in. (32 mm) OD
<b>Pump Air Supply</b>	1/2 in. (13 mm) OD
<b>Air Exhaust</b>	5/8 in. (16 mm) OD
<b>Hose Material</b>	Nitrile
<b>Sizes - Liquid Discharge</b>	3/4 in. (19 mm) or 1 in. (25 mm) ID
<b>Pump Air Supply</b>	3/8 in. (9.5 mm) ID
<b>Air Exhaust</b>	1/2 in. (13 mm) ID

<sup>2</sup> Applies to QED supplied tubing; other tubing sources may not conform to QED fittings.

<sup>3</sup> PVDF - Polyvinylidene Fluoride

### Application Limits (Base model)

AutoPump AP4 Ultra pumps are designed to handle the application ranges described below. For applications outside these ranges, consult QED about AP4 upgrades.

AutoPump AP4 Ultra Long and Short pumps are warranted for five (5) years: 100% materials and workmanship.

\*Consult QED for higher flow requirements

### Flow Rates<sup>1</sup>

**3/4 inch (19 mm)  
Inside Diameter Discharge Hose**  
(Equivalent to 1-Inch O.D. Tubing)

**1 inch (25.4 mm)  
Inside Diameter Discharge Hose**  
(Equivalent to 1.25-Inch O.D. Tubing)

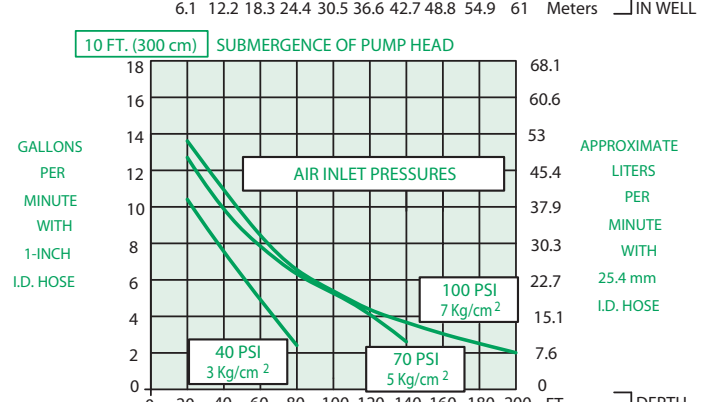
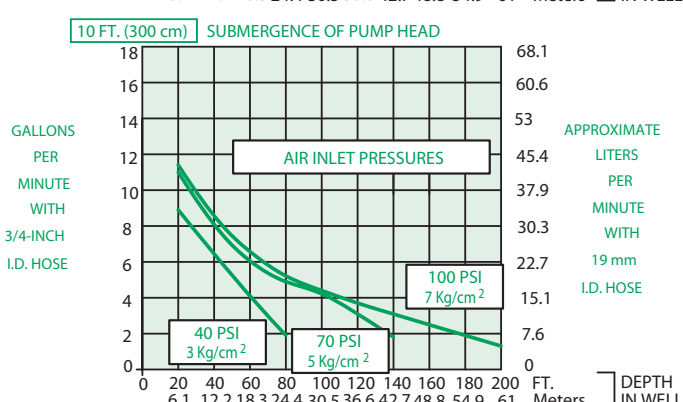
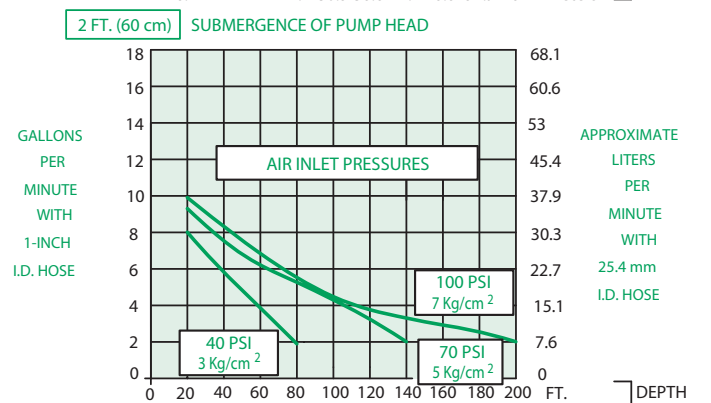
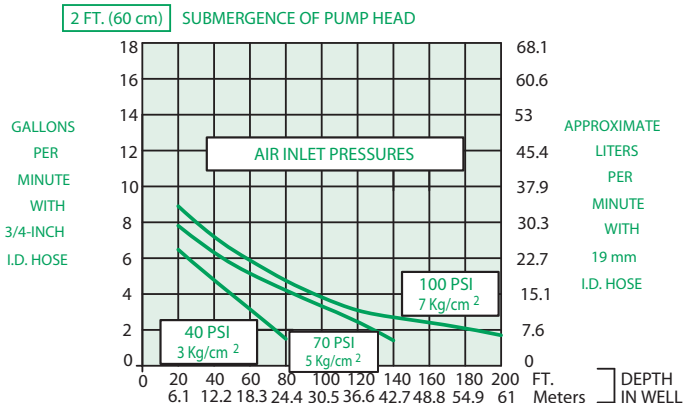
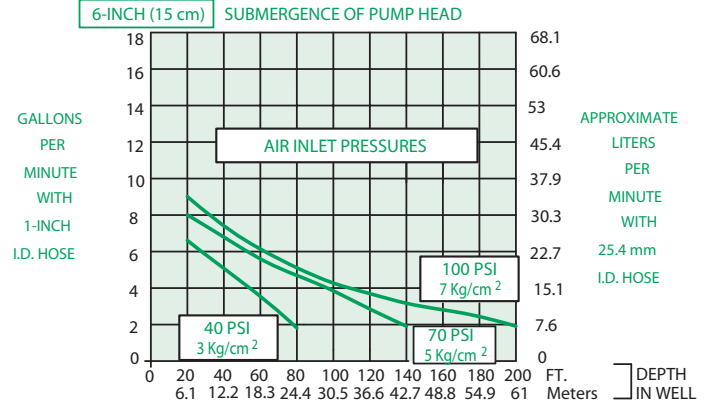
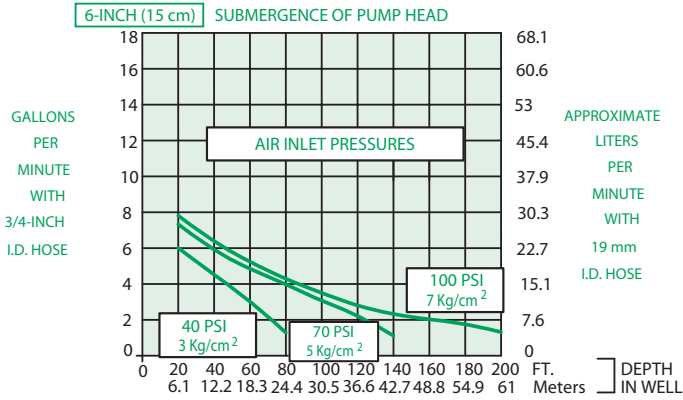

<sup>1</sup>FLOW RATES MAY VARY WITH SITE CONDITIONS. CALL QED FOR TECHNICAL ASSISTANCE.



### Air Consumption

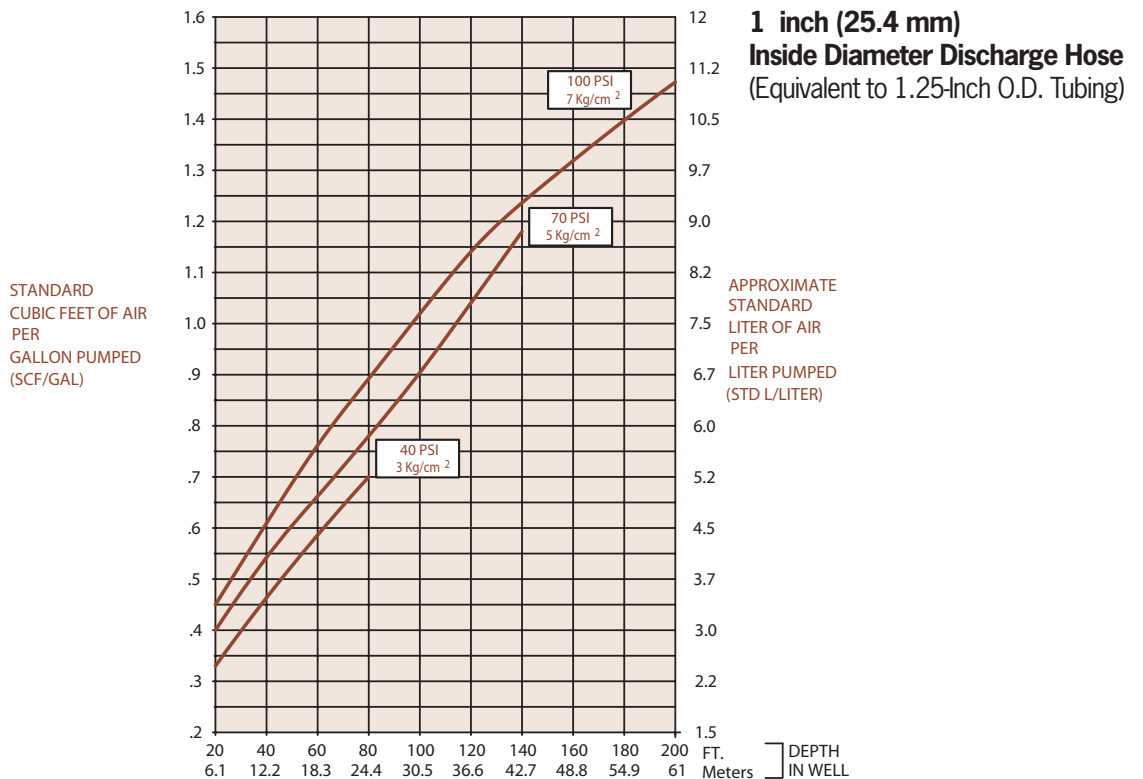
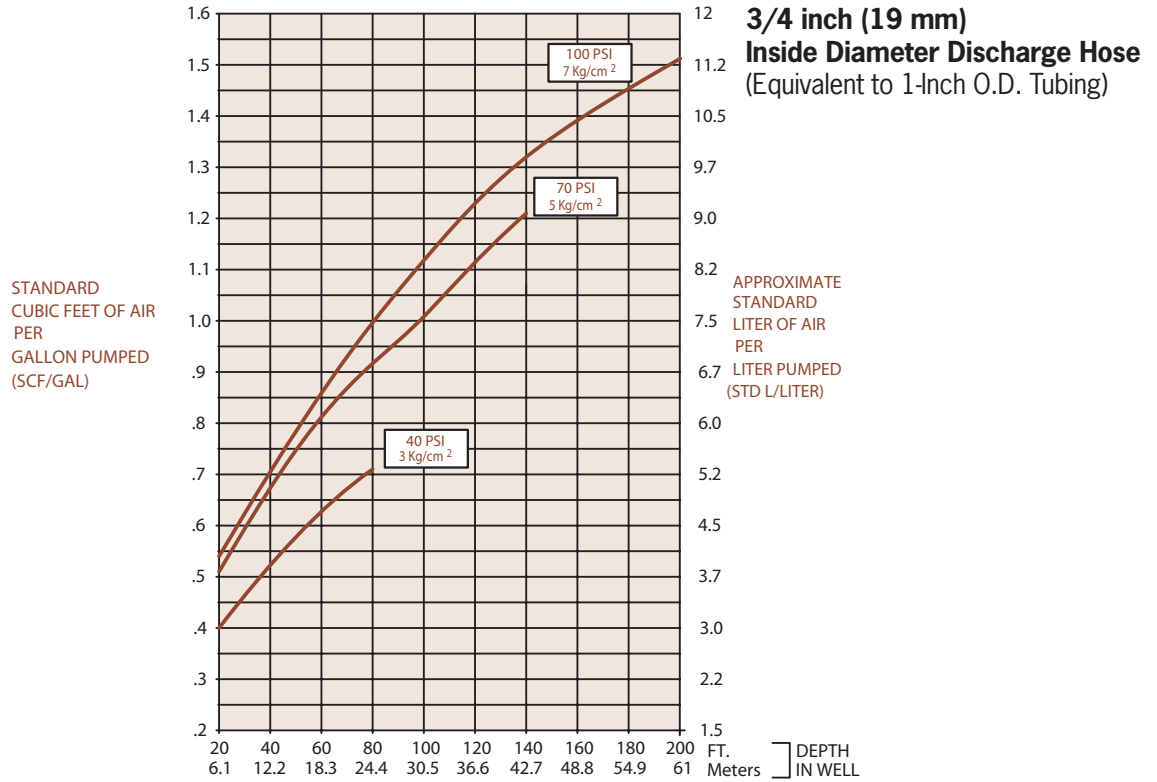

# AP4.0T

# AutoPump® AP4 Ultra

## Top Inlet, Long

**Max. Flow** 10 gpm (38 lpm)

**O.D.** 3.6 in. (9.1 cm)

**Length** 56.7 in. (144 cm)

### Description

The AutoPump® AP4 Ultra Top Inlet Long provides maximum capabilities and flow in a top inlet pump for 4" diameter and larger wells needing an elevated inlet, such as pumping total fluids from wells contaminated with LNAPLs, and it can deliver flow rates up to 10 gpm (38 lpm)\*. The AP4 Ultra uses proprietary non-stick finishes on the float and discharge tube to reduce solids buildup, extending the time between cleaning and making it much faster and easier to clean the pump. All metallic parts are 316-grade Stainless Steel, which has greater corrosion resistance and can withstand attacks of the harshest leachate. The AP4.0 Top Inlet Long pump is complemented by the most comprehensive selection of accessories to provide a complete system to meet site-specific requirements. Call QED for prompt, no-obligation assistance on your pumping project needs.

### The AutoPump Heritage

The AutoPump AP4 Ultra Top Inlet Long is part of the famous AutoPump family of original automatic air-powered pumps, developed in the mid 1980s specifically to handle unique pumping needs at remediation and landfill sites. Over the years they've proven their durability at thousands of sites worldwide. AutoPumps are designed to handle difficult pumping challenges that other pumps can't, such as hydrocarbons, solvents, suspended solids, corrosives, temperature extremes, viscous fluids and frequent start/stop cycles. Beyond just the pump, AutoPump systems offer the most complete range of tubing, hose, connectors, wellhead caps and accessories to help your installation go smoothly. This superior pumping heritage, application experience and support back up every AutoPump you put to work on your project.

### Advantages

1. **The original automatic air-powered well pump, proven worldwide over 30 years.**
2. **Proprietary finishes extend the time between cleaning.**
3. **All metallic parts are 316-grade SS for better corrosion resistance.**
4. **New and improved valve stem connections have no fasteners, or cotter pins. Exhaust seat is easy to adjust.**
5. **Five-year warranty.**

\*Consult QED for higher flow requirements



### Pump Dimensions

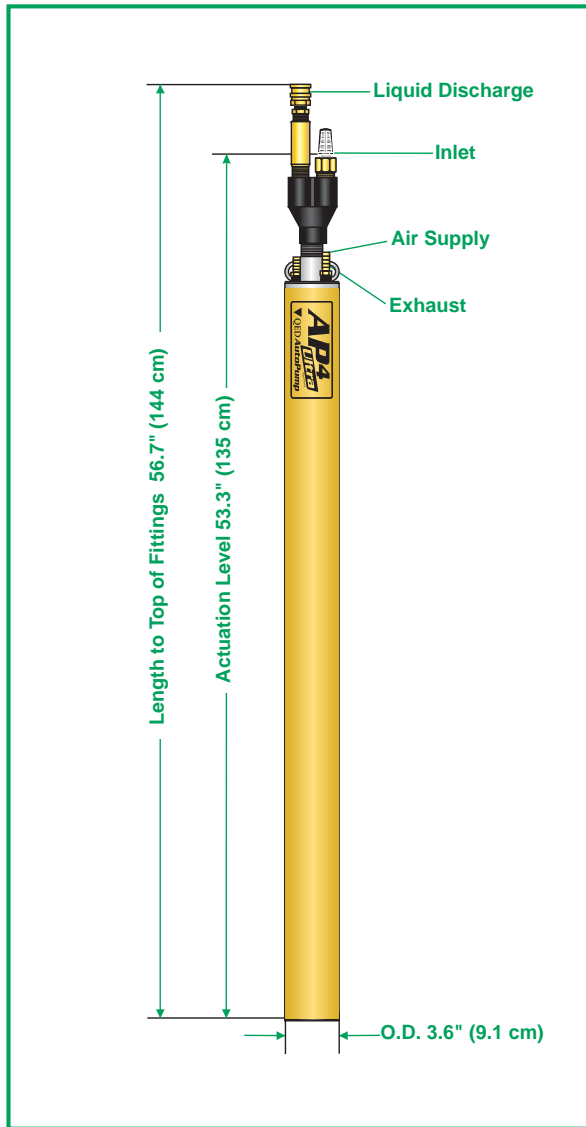

### Specifications & Operating Requirements

<b>Model</b>	<b>4" - Long AP4 Ultra Top Inlet</b>
<b>Liquid Inlet Location</b>	Top
<b>OD</b>	3.6 in. (9.1 cm)
<b>Length Overall (pump &amp; fittings)</b>	56.7 in. (144 cm)
<b>Weight</b>	18 lbs. (8.7 kg)
<b>Max. Flow Rate</b>	10 gpm (38 lpm) - See Flow Rate Chart
<b>Pump Volume / Cycle</b>	0.58 - 0.78 gal (2.2 - 3.0L)
<b>Min. Actuation Level</b>	53.3 in. (135 cm)
<b>Standard Pump</b>	
<b>Max. Depth</b>	250 ft. (76 m)
<b>Air Pressure Range</b>	5 - 120 psi (0.4 - 8.4 kg/cm <sup>2</sup> )
<b>Air Usage</b>	0.35-1.1 scf / gal. (3.0-8.4 liters of air / fluid liter)
<b>High Pressure Pump</b>	
<b>Max. Depth</b>	425 ft. (130 m)
<b>Air Pressure Range</b>	5 - 200 psi (0.4 - 14.1 kg/cm <sup>2</sup> )
<b>Min. Liquid Density</b>	
	0.7 SpG (0.7 g/cm <sup>3</sup> )
<b>Standard Construction Materials<sup>1</sup></b>	
<b>Pump Body</b>	Fiberglass or Stainless Steel
<b>Pump Ends</b>	316 Stainless Steel, Acetal
<b>Internal Components</b>	316 Stainless Steel, Viton, Acetal, PVDF
<b>Tube &amp; Hose Fittings</b>	316 Stainless Steel
<b>Fitting Type</b>	Barbs or Quick Connects or Easy Fittings
<b>Tube &amp; Hose Options</b>	
<b>Tubing Material<sup>2</sup></b>	Nylon
<b>Sizes - Liquid Discharge</b>	1 in. (25 mm) or 1-1/4 in. (32 mm) OD
<b>Pump Air Supply</b>	1/2 in. (13 mm) OD
<b>Air Exhaust</b>	5/8 in. (16 mm) OD
<b>Hose Material</b>	Nitrile
<b>Sizes - Liquid Discharge</b>	3/4 in. (19 mm) or 1 in. (25 mm) ID
<b>Pump Air Supply</b>	3/8 in. (9.5 mm) ID
<b>Air Exhaust</b>	1/2 in. (13 mm) ID

<sup>1</sup> Material upgrades available  
<sup>2</sup> Applies to QED supplied tubing;  
 other tubing sources may not  
 conform to QED fittings.

<sup>3</sup> PVDF - Polyvinylidene Fluoride

### Standard Application Limits (standard model)

AutoPump AP4 Ultra pumps are designed to handle the application ranges described below. For applications outside these ranges, consult QED.

AutoPump AP4 Ultra Long and Short pumps are warranted for five (5) years: 100% materials and workmanship.

### Flow Rates<sup>1</sup>

**3/4 inch (19 mm)  
Inside Diameter Discharge Hose  
(Equivalent to 1-Inch O.D. Tubing)**

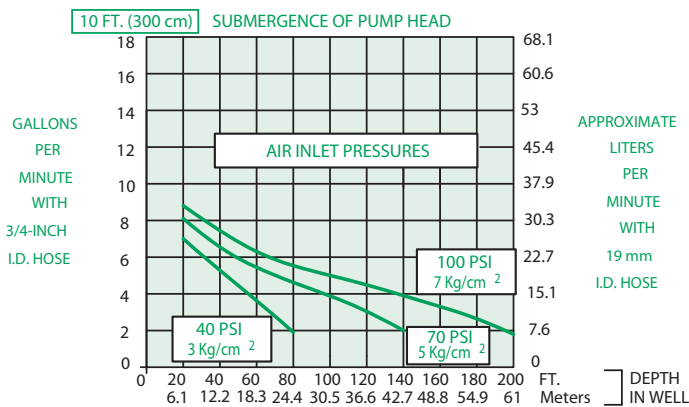
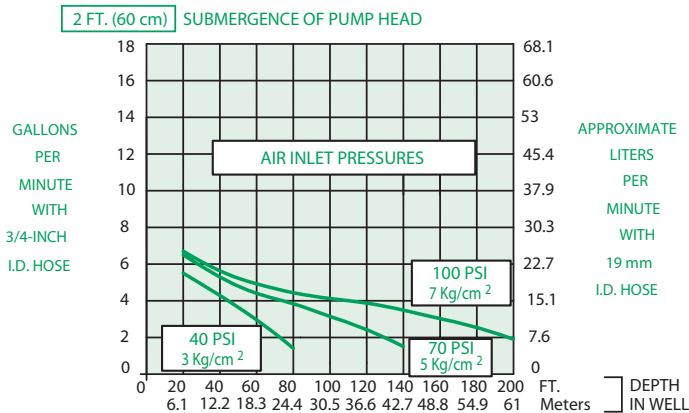
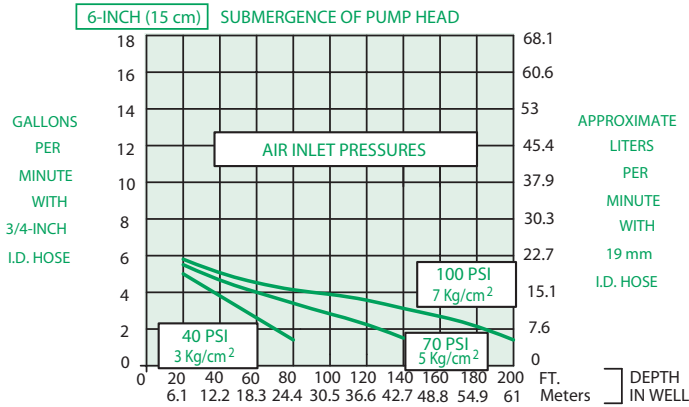

**1 inch (25.4 mm)  
Inside Diameter Discharge Hose  
(Equivalent to 1.25-Inch O.D. Tubing)**

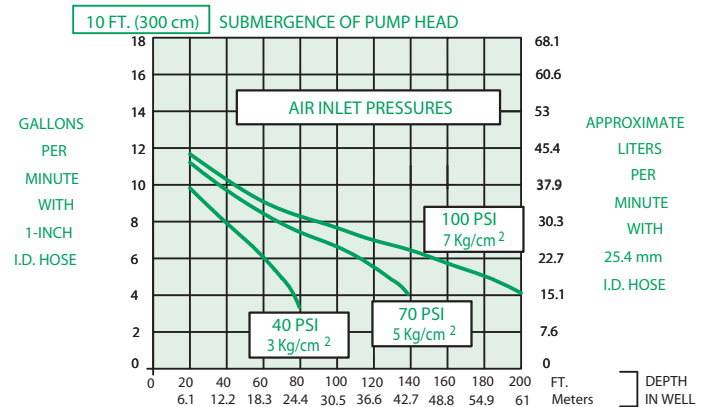
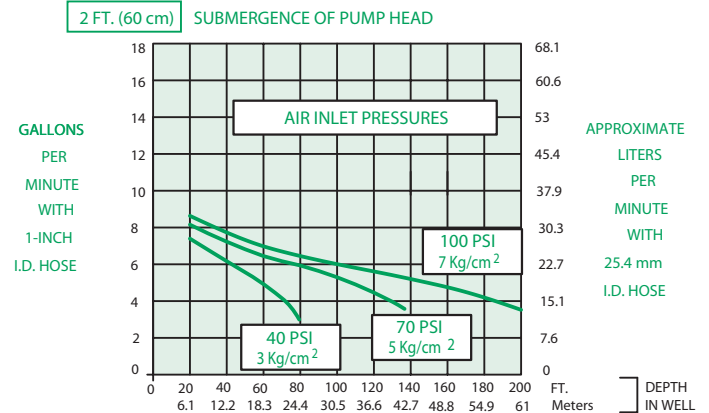
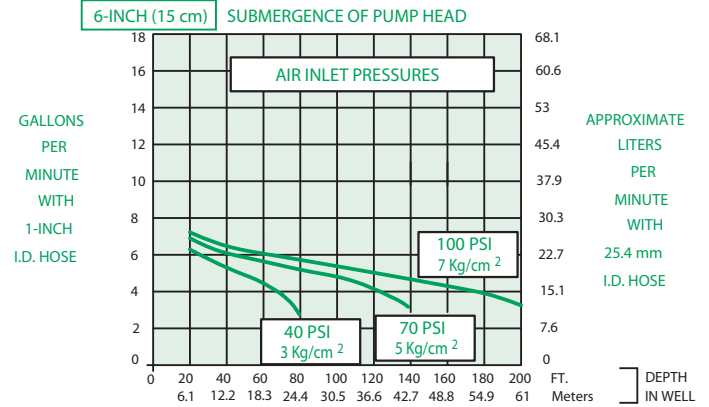

<sup>1</sup>FLOW RATES MAY VARY WITH SITE CONDITIONS. CALL QED FOR TECHNICAL ASSISTANCE.



### Air Consumption

STANDARD  
CUBIC FEET OF AIR  
PER  
GALLON PUMPED  
(SCF/GAL)

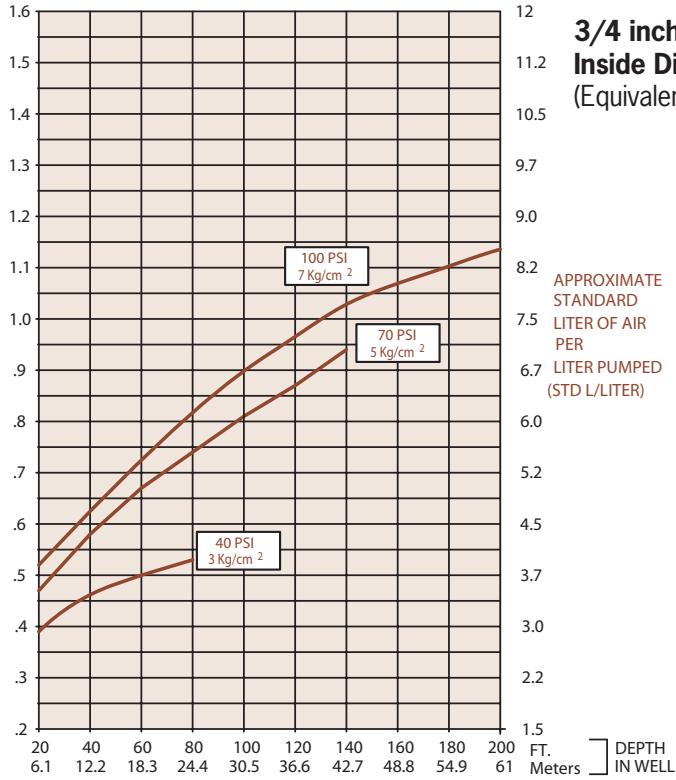

STANDARD  
CUBIC FEET OF AIR  
PER  
GALLON PUMPED  
(SCF/GAL)

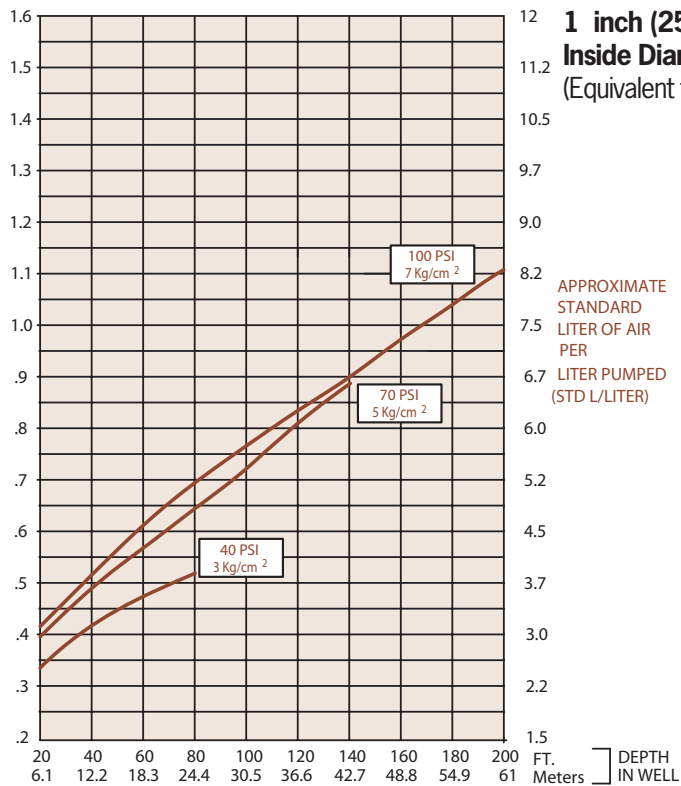

# AP4.0T

# AutoPump® AP4 Ultra

## Top Inlet, Short

**Max. Flow** 9 gpm (34 lpm)

**O.D.** 3.6 in. (9.1 cm)

**Length** 45 in. (110 cm)

### Description

The AutoPump AP4 Ultra Top Inlet Short provides maximum capabilities and flow in a top inlet pump for 4" (100 mm) diameter and larger wells with shorter water columns and the need for an elevated inlet, such as pumping total fluids from wells contaminated with LNAPLs, and it can deliver flow rates up to 9 gpm (34 lpm)\*. The AP4 Ultra uses proprietary non-stick finishes on the float and discharge tube to reduce solids buildup, extending the time between cleaning and making it much faster and easier to clean the pump. All metallic parts are 316-grade Stainless Steel, which has greater corrosion resistance and can withstand attacks of the harshest leachate. The AP4.0 Top Inlet Short pump is complemented by the most comprehensive selection of accessories to provide a complete system to meet site-specific requirements. Call QED for prompt, no-obligation assistance on your pumping project needs.



### The AutoPump Heritage

The AutoPump AP4 Ultra Top Inlet Short is part of the famous AutoPump family of original automatic air-powered pumps, developed in the mid 1980s specifically to handle unique pumping needs at remediation and landfill sites. Over the years they've proven their durability at thousands of sites worldwide. AutoPumps are designed to handle difficult pumping challenges that other pumps can't, such as hydrocarbons, solvents, suspended solids, corrosives, temperature extremes, viscous fluids and frequent start/stop cycles. Beyond just the pump, AutoPump systems offer the most complete range of tubing, hose, connectors, wellhead caps and accessories to help your installation go smoothly. This superior pumping heritage, application experience and support back up every AutoPump you put to work on your project.

### Advantages

1. The original automatic air-powered well pump, proven worldwide over 30 years.
2. Proprietary finishes extend the time between cleaning.
3. All metallic parts are 316-grade SS for better corrosion resistance.
4. New and improved valve stem connections have no fasteners, or cotter pins. Exhaust seat is easy to adjust.
5. Five-year warranty.

### Pump Dimensions

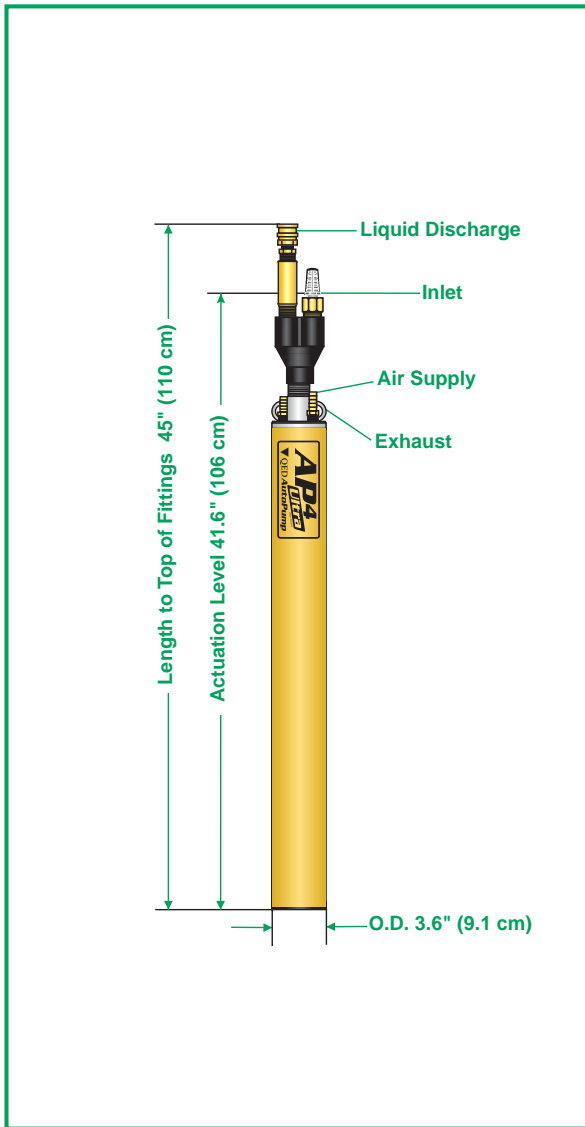

### Standard Application Limits (standard model)

AutoPump AP4 Ultra pumps are designed to handle the application ranges described below. For applications outside these ranges, consult QED.

### Specifications & Operating Requirements

<b>Model</b>	<b>4" - Short AP4 Ultra Top Inlet</b>
<b>Liquid Inlet Location</b>	Top
<b>OD</b>	3.6 in. (9.1 cm)
<b>Length Overall (pump &amp; fittings)</b>	45 in. (110 cm)
<b>Weight</b>	17 lbs. (7.8 kg)
<b>Max. Flow Rate</b>	9 gpm (34 lpm) - See Flow Rate Chart
<b>Pump Volume / Cycle</b>	0.22 - 0.36 gal (.83 - 1.36L )
<b>Min. Actuation Level</b>	41.6 in. (106 cm)
<b>Standard Pump</b>	
<b>Max. Depth</b>	250 ft. (76 m)
<b>Air Pressure Range</b>	5 - 120 psi (0.4 - 8.4 kg/cm2)
<b>Air Usage</b>	0.35-1.5 scf / gal. (2.4-11.3 liters of air / fluid liter) - See Air Usage Chart
<b>High Pressure Pump</b>	
<b>Max. Depth</b>	425 ft. (130 m)
<b>Air Pressure Range</b>	5 - 200 psi (0.4 - 14.1 kg/cm2)
<b>Min. Liquid Density</b>	0.7 SpG (0.7 g/cm3)
<b>Standard Construction Materials<sup>1</sup></b>	
<b>Pump Body</b>	Fiberglass or Stainless Steel
<b>Pump Ends</b>	316 Stainless Steel
<b>Internal Components</b>	316 Stainless Steel, Viton, Acetal, PVDF
<b>Tube &amp; Hose Fittings</b>	316 Stainless Steel
<b>Fitting Type</b>	Barbs or Quick Connects or Easy Fittings
<b>Tube &amp; Hose Options</b>	
<b>Tubing Material<sup>2</sup></b>	Nylon
<b>Sizes - Liquid Discharge</b>	1 in. (25 mm) or 1-1/4 in. (32 mm) OD
<b>Pump Air Supply</b>	1/2 in. (13 mm) OD
<b>Air Exhaust</b>	5/8 in. (16 mm) OD
<b>Hose Material</b>	Nitrile
<b>Sizes - Liquid Discharge</b>	3/4 in. (19 mm) or 1 in. (25 mm) ID
<b>Pump Air Supply</b>	3/8 in. (9.5 mm) ID
<b>Air Exhaust</b>	1/2 in. (13 mm) ID

<sup>1</sup> Material upgrades available  
<sup>2</sup> Applies to QED supplied tubing; other tubing sources may not conform to QED fittings.

<sup>3</sup> PVDF - Polyvinylidene Fluoride

AutoPump AP4 Ultra Long and Short pumps are warranted for five (5) years: 100% materials and workmanship.

### Flow Rates<sup>1</sup>

**3/4 inch (19 mm)  
Inside Diameter Discharge Hose  
(Equivalent to 1-Inch O.D. Tubing)**

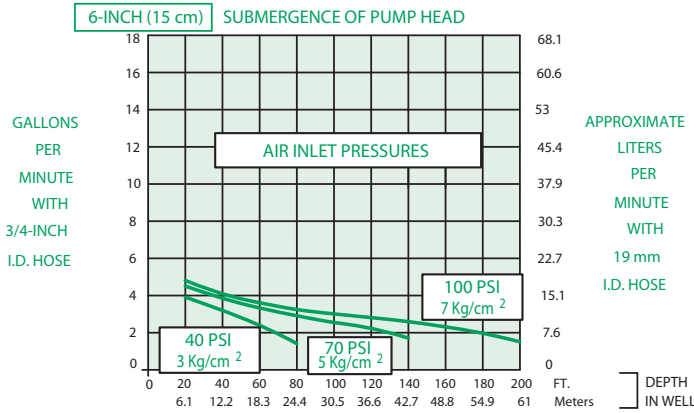

**1 inch (25.4 mm)  
Inside Diameter Discharge Hose  
(Equivalent to 1.25-Inch O.D. Tubing)**

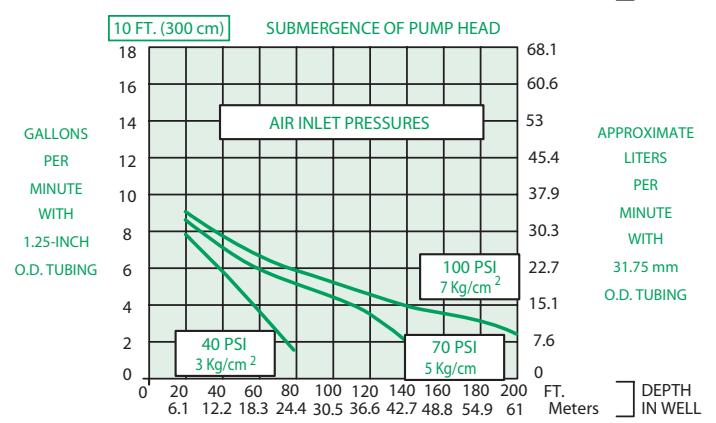
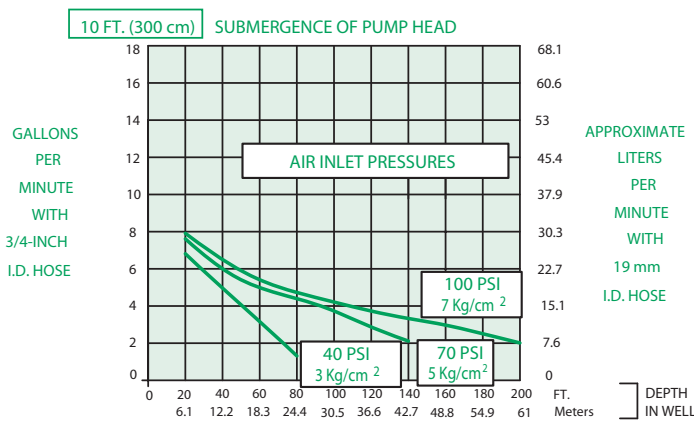
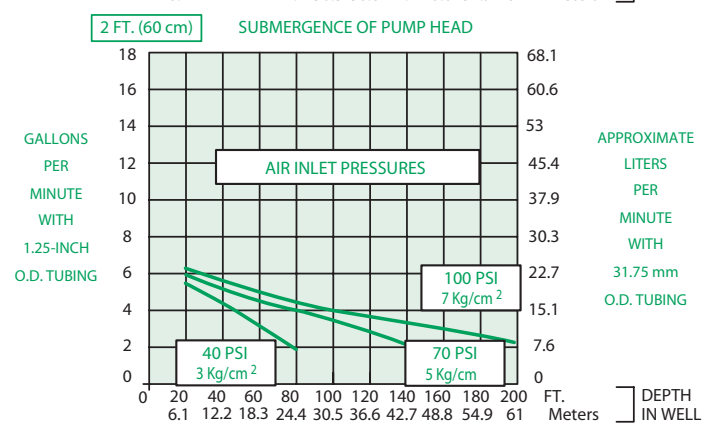
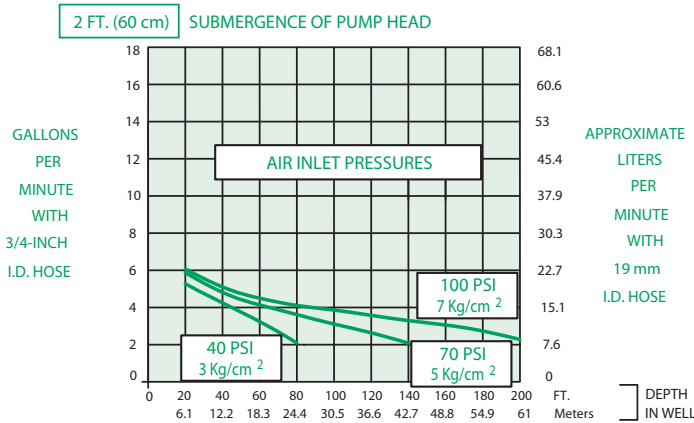
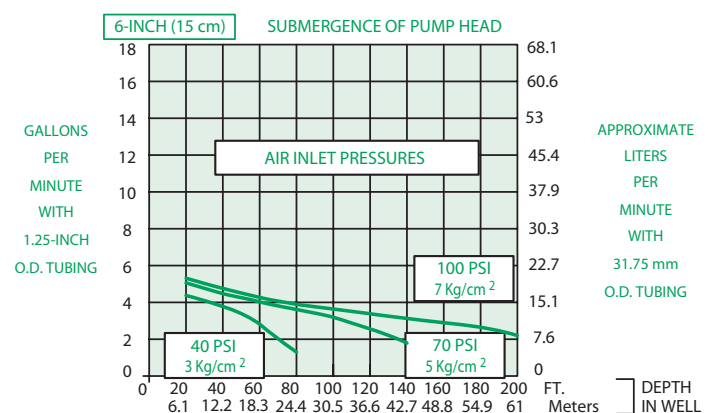

<sup>1</sup>FLOW RATES MAY VARY WITH SITE CONDITIONS. CALL QED FOR TECHNICAL ASSISTANCE.



### Air Consumption

STANDARD  
CUBIC FEET OF AIR  
PER  
GALLON PUMPED  
(SCF/GAL)

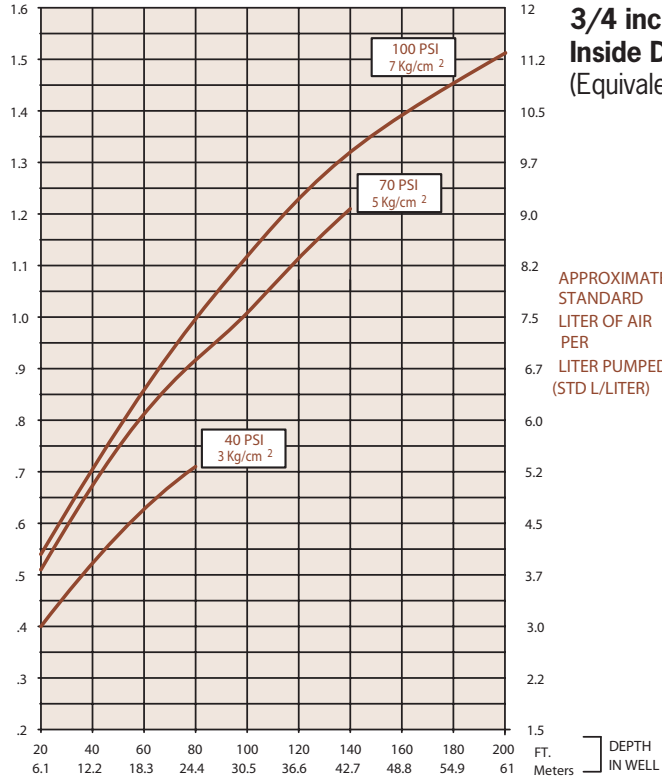

APPROXIMATE  
STANDARD  
LITER OF AIR  
PER  
LITER PUMPED  
(STD L/LITER)

STANDARD  
CUBIC FEET OF AIR  
PER  
GALLON PUMPED  
(SCF/GAL)

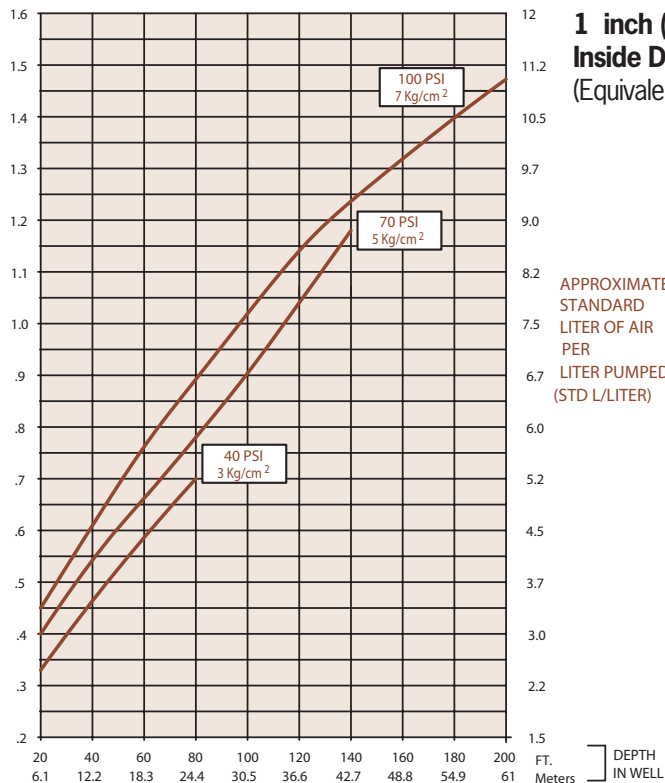

APPROXIMATE  
STANDARD  
LITER OF AIR  
PER  
LITER PUMPED  
(STD L/LITER)

## AP4+B

## Bottom Inlet, Long

**Max. Flow** 14 gpm (53 lpm)\*

**O.D.** 3.6 in. (9.1 cm)

**Length** 51.4 in. (131 cm)



### Description

The AP4+ Bottom Inlet Long AutoPump provides maximum capabilities and flow in a bottom inlet pump for 4" (100 mm) diameter and larger wells. The base model delivers flow rates up to 14 gpm (53 lpm)\*, and optional versions are offered to handle even the most severe remediation and landfill pumping applications. The AP4+ Long Bottom Inlet AutoPump is complemented by the most comprehensive selection of accessories to provide a complete system to meet site-specific requirements. Call QED for prompt, no-obligation assistance on your pumping project needs.

### The AutoPump Heritage

The AP4+ Bottom Inlet Long AutoPump is part of the famous AutoPump family of original automatic air-powered pumps, developed in the mid 1980s specifically to handle unique pumping needs at remediation and landfill sites. Over the years they've proven their durability at thousands of sites worldwide. AutoPumps are designed to handle difficult pumping challenges that other pumps can't, such as hydrocarbons, solvents, suspended solids, corrosives, temperature extremes, viscous fluids and frequent start/stop cycles. Beyond just the pump, AutoPump systems offer the most complete range of tubing, hose, connectors, wellhead caps and accessories to help your installation go smoothly. This superior pumping heritage, application experience and support back up every AutoPump you put to work on your project.

### Advantages

1. The original automatic air-powered well pump, proven worldwide over 25 years
2. The highest flow rates and deepest pumping capabilities in the industry
3. Patented, proven design for superior reliability and durability, even in severe applications
4. Handles solids, solvents, hydrocarbons corrosive conditions, viscous fluids and high temperatures beyond the limits of electric pumps
5. Five-year warranty



### Pump Dimensions

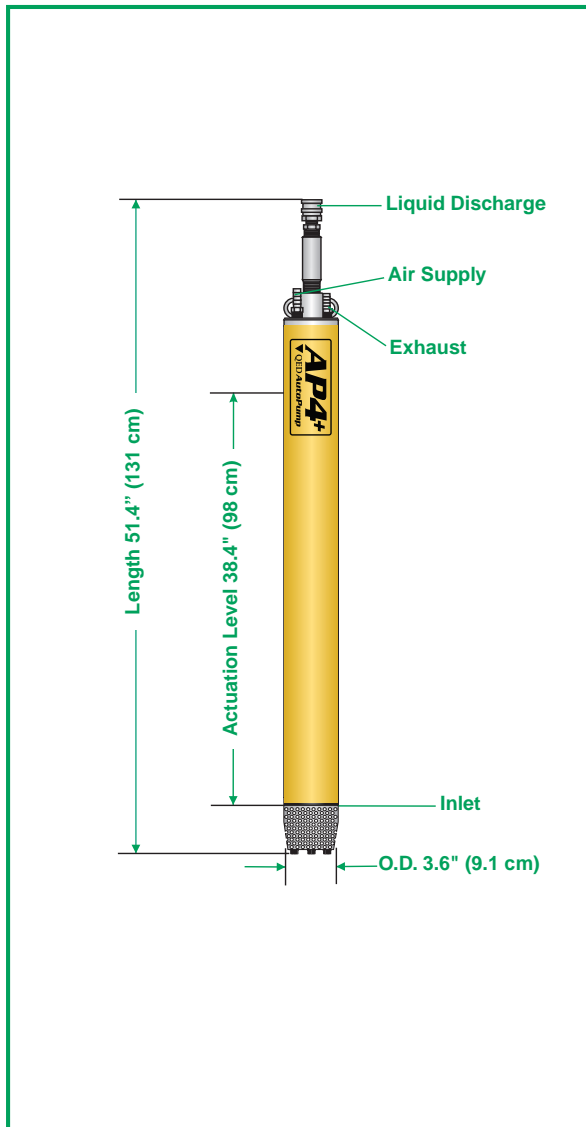

### Specifications & Operating Requirements

<b>Model</b>	<b>4" - Long AP4+ Bottom Inlet</b>
<b>Liquid Inlet Location</b>	Bottom
<b>OD</b>	3.6 in. (9.1 cm)
<b>Length Overall (pump &amp; fittings)</b>	51.4 in. (131 cm)
<b>Weight</b>	16 lbs. (7.3 kg)
<b>Max. Flow Rate</b>	14 gpm (53 lpm) - See Flow Rate Chart*
<b>Pump Volume / Cycle</b>	0.58 - 0.78 gal. (2.2 - 3.0L)
<b>Min. Actuation Level</b>	38.4 in. (98 cm)
<b>Standard Pump</b>	
<b>Max. Depth</b>	250 ft. (76 m)
<b>Air Pressure Range</b>	5 - 120 psi (0.4 - 8.4 kg/cm <sup>2</sup> )
<b>Air Usage</b>	0.4-1.1 scf / gal. (3.0-8.5 liters of air / fluid liter) - See Air Usage Chart
<b>High Pressure Pump</b>	
<b>Max. Depth</b>	425 ft. (130 m)
<b>Air Pressure Range</b>	5 - 200 psi (0.4 - 14.1 kg/cm <sup>2</sup> )
<b>Min. Liquid Density</b>	0.7 SpG (0.7 g/cm <sup>3</sup> )
<b>Standard Construction Materials<sup>1</sup></b>	
<b>Pump Body</b>	Fiberglass or Stainless Steel
<b>Pump Ends</b>	Stainless Steel
<b>Internal Components</b>	Stainless Steel, Viton, PVDF <sup>3</sup>
<b>Tube &amp; Hose Fittings</b>	Brass or Stainless Steel
<b>Fitting Type</b>	Barbs or Quick Connects
<b>Tube &amp; Hose Options</b>	
<b>Tubing Material<sup>2</sup></b>	Nylon
<b>Sizes - Liquid Discharge</b>	1 in. (25 mm) or 1-1/4 in. (32 mm) OD
<b>Pump Air Supply</b>	1/2 in. (13 mm) OD
<b>Air Exhaust</b>	5/8 in. (16 mm) OD
<b>Hose Material</b>	Nitrile
<b>Sizes - Liquid Discharge</b>	3/4 in. (19 mm) or 1 in. (25 mm) ID
<b>Pump Air Supply</b>	3/8 in. (9.5 mm) ID
<b>Air Exhaust</b>	1/2 in. (13 mm) ID

<sup>1</sup> Material upgrades available

<sup>3</sup> PVDF - Polyvinylidene Fluoride

<sup>2</sup> Applies to QED supplied tubing; other tubing sources may not conform to QED fittings.

### Application Limits (Base model)

AP4+ AutoPumps are designed to handle the application ranges described below. For applications outside these ranges, consult QED about AP4 upgrades.

Maximum Temperature: 150°F (65°C)

pH Range: 4-9

Solvents and Fuels: diesel, gasoline, JP1-JP6, #2 heating oils, BTEX, MTBE, landfill liquids

\*Consult QED for higher flow requirements

Long and Short AP4+ AutoPumps are warranted for five (5) years: 100% materials and workmanship.

Low-Drawdown AutoPumps are warranted for one (1) year: 100% materials and workmanship.

### Flow Rates<sup>1</sup>

**3/4 inch (19 mm)  
Inside Diameter Discharge Hose  
(Equivalent to 1-Inch O.D. Tubing)**

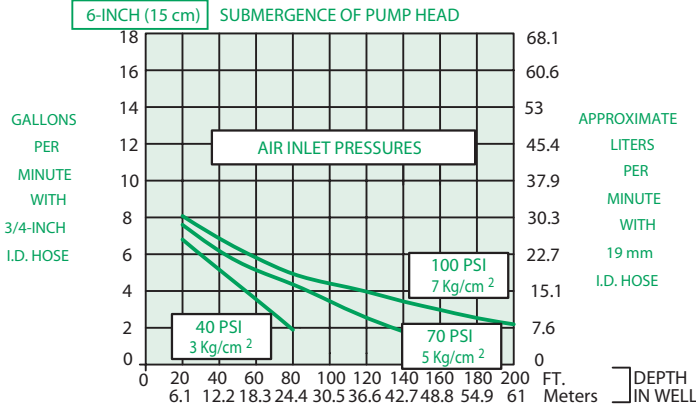

**1 inch (25.4 mm)  
Inside Diameter Discharge Hose  
(Equivalent to 1.25-Inch O.D. Tubing)**

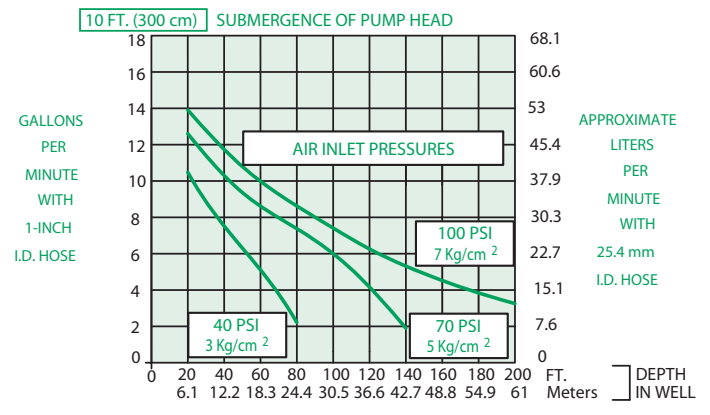
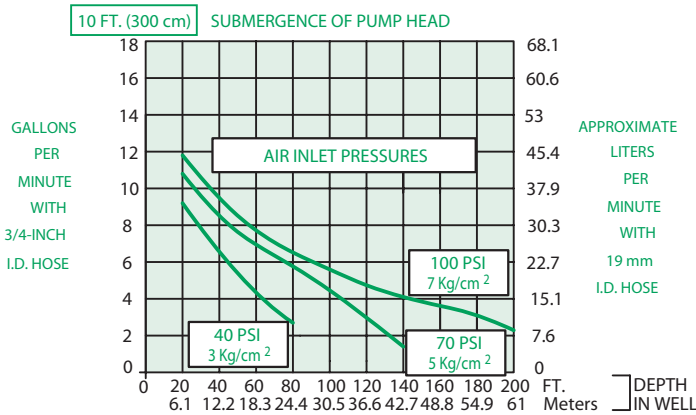
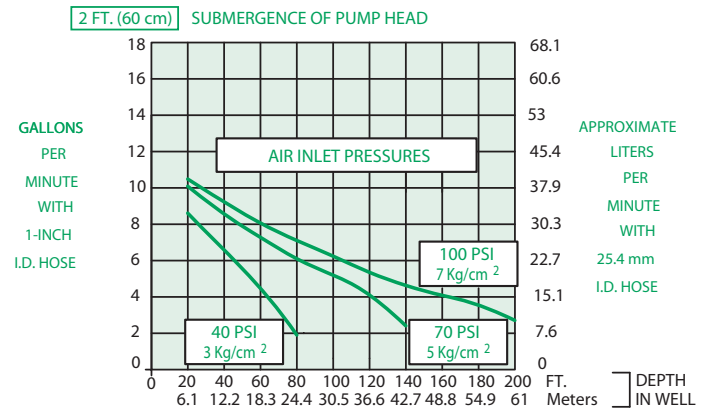
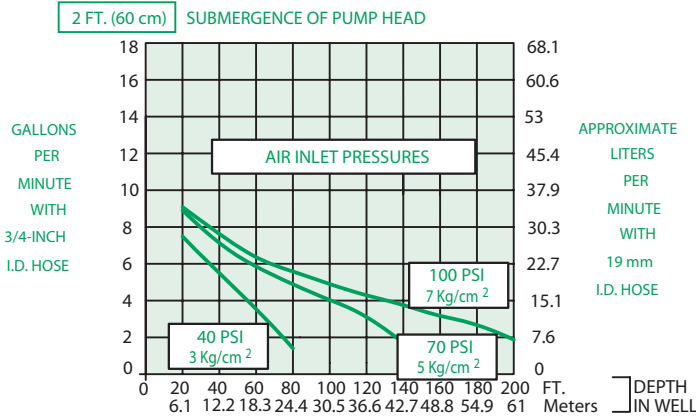
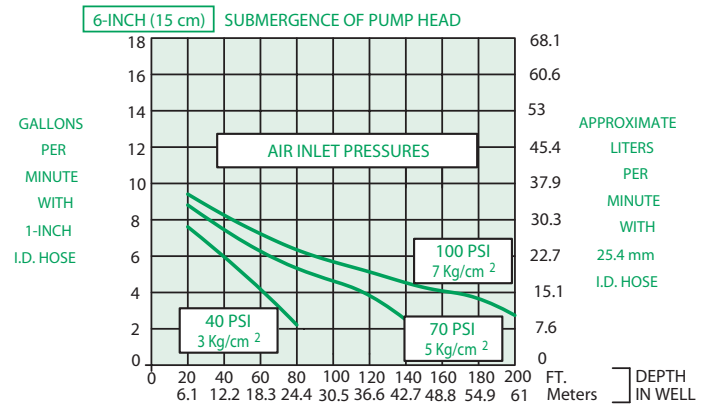

<sup>1</sup>FLOW RATES MAY VARY WITH SITE CONDITIONS. CALL QED FOR TECHNICAL ASSISTANCE.



### Air Consumption

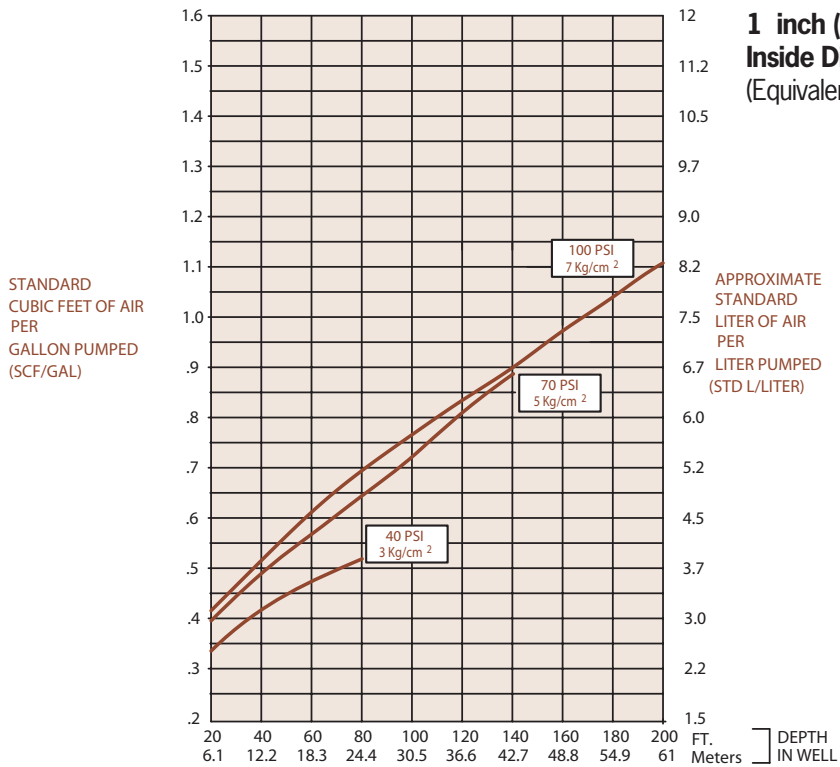
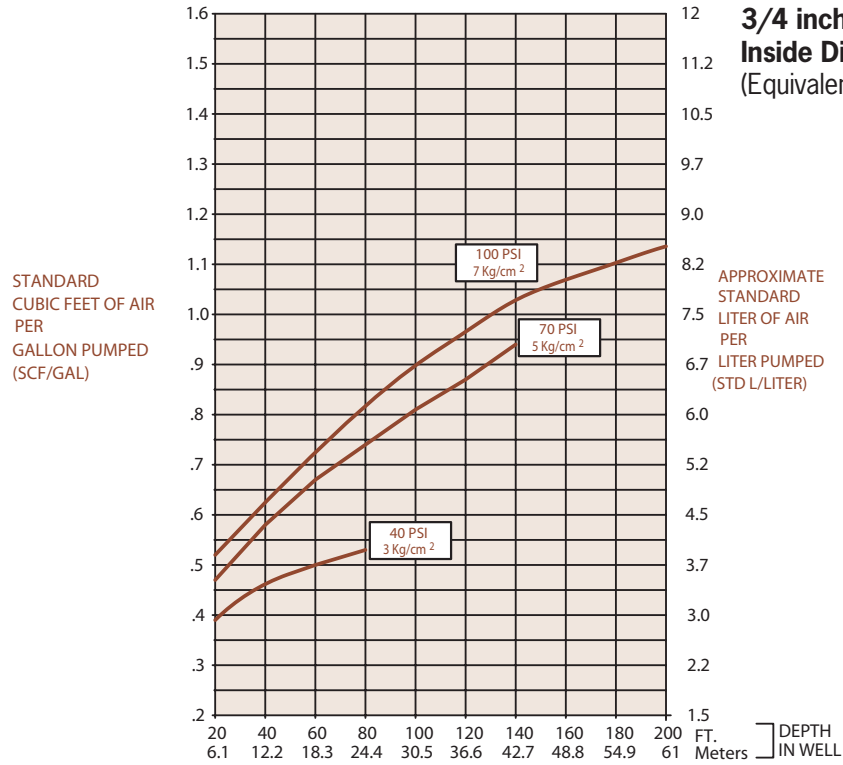

# AP4+B

# AutoPump®

## Bottom Inlet, Short

**Max. Flow** 13 gpm (49 lpm)

**O.D.** 3.6 in. (9.1 cm)

**Length** 39.3 in. (100 cm)



### Description

The AP4+ Bottom Inlet Short AutoPump provides maximum capabilities and flow in a bottom inlet pump for 4" (100 mm) diameter and larger wells with shorter water columns and/or the need to pump down to lower water levels, compared to full-length pumps. It is offered in optional versions to handle even the most severe remediation and landfill pumping applications, and delivers flow rates up to 13 gpm (49 lpm)\*. The AP4+ Short Bottom Inlet AutoPump is complemented by the most comprehensive selection of accessories to provide a complete system to meet site-specific requirements. Call QED for prompt, no-obligation assistance on your pumping project needs.

### The AutoPump Heritage

The AP4+ Bottom Inlet Short AutoPump is part of the famous AutoPump family of original automatic air-powered pumps, developed in the mid 1980s specifically to handle unique pumping needs at remediation and landfill sites. Over the years they've proven their durability at thousands of sites worldwide. AutoPumps are designed to handle difficult pumping challenges that other pumps can't, such as hydrocarbons, solvents, suspended solids, corrosives, temperature extremes, viscous fluids and frequent start/stop cycles. Beyond just the pump, AutoPump systems offer the most complete range of tubing, hose, connectors, wellhead caps and accessories to help your installation go smoothly. This superior pumping heritage, application experience and support back up every AutoPump you put to work on your project.

### Advantages

1. The original automatic air-powered well pump, proven worldwide over 25 years
2. The highest flow rates and deepest pumping capabilities in the industry
3. Patented, proven design for superior reliability and durability, even in severe applications
4. Handles solids, solvents, hydrocarbons corrosive conditions, viscous fluids and high temperatures beyond the limits of electric pumps
5. Five-year warranty

\*Consult QED for higher flow requirements

### Pump Dimensions

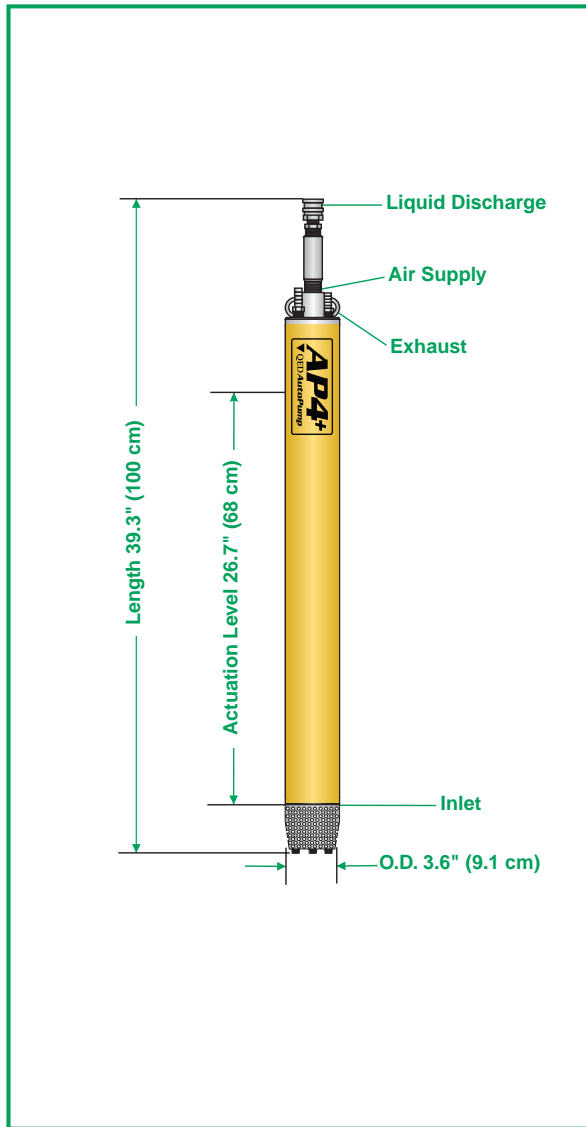

### Specifications & Operating Requirements

<b>Model</b>	<b>4" - Short AP4+ Bottom Inlet</b>
<b>Liquid Inlet Location</b>	Bottom
<b>OD</b>	3.6 in. (9.1 cm)
<b>Length Overall (pump &amp; fittings)</b>	39.3 in. (100 cm)
<b>Weight</b>	13 lbs. (5.9 kg)
<b>Max. Flow Rate</b>	13 gpm (49 lpm)* - See Flow Rate Chart
<b>Pump Volume / Cycle</b>	0.22 - 0.36 gal (.83 - 1.36L)
<b>Min. Actuation Level</b>	26.7 in. (68 cm)
<b>Standard Pump</b>	
<b>Max. Depth</b>	250 ft. (76 m)
<b>Air Pressure Range</b>	5 - 120 psi (0.4 - 8.4 kg/cm <sup>2</sup> )
<b>Air Usage</b>	0.4-1.5 scf / gal. (1.5 - 5.7 liters of air / fluid liter) - See Air Usage Chart
<b>High Pressure Pump</b>	
<b>Max. Depth</b>	425 ft. (130 m)
<b>Air Pressure Range</b>	5 - 200 psi (0.4 - 14.1 kg/cm <sup>2</sup> )
<b>Min. Liquid Density</b>	0.7 SpG (0.7 g/cm <sup>3</sup> )
<b>Standard Construction Materials<sup>1</sup></b>	
<b>Pump Body</b>	Fiberglass or Stainless Steel
<b>Pump Ends</b>	Stainless Steel
<b>Internal Components</b>	Stainless Steel, Viton, PVDF <sup>3</sup>
<b>Tube &amp; Hose Fittings</b>	Brass or Stainless Steel
<b>Fitting Type</b>	Barbs or Quick Connects
<b>Tube &amp; Hose Options</b>	
<b>Tubing Material<sup>2</sup></b>	Nylon
<b>Sizes - Liquid Discharge</b>	1 in. (25 mm) or 1-1/4 in. (32 mm) OD
<b>Pump Air Supply</b>	1/2 in. (13 mm) OD
<b>Air Exhaust</b>	5/8 in. (16 mm) OD
<b>Hose Material</b>	Nitrile
<b>Sizes - Liquid Discharge</b>	3/4 in. (19 mm) or 1 in. (25 mm) ID
<b>Pump Air Supply</b>	3/8 in. (9.5 mm) ID
<b>Air Exhaust</b>	1/2 in. (13 mm) ID

<sup>1</sup> Material upgrades available

<sup>3</sup> PVDF - Polyvinylidene Fluoride

<sup>2</sup> Applies to QED supplied tubing; other tubing sources may not conform to QED fittings.

### Application Limits (Base model)

AP4+ AutoPumps are designed to handle the application ranges described below. For applications outside these ranges, consult QED about AP4 upgrades.

Maximum Temperature: 150°F (65°C)

pH Range: 4-9

Solvents and Fuels: diesel, gasoline, JP1-JP6, #2 heating oils, BTEX, MTBE, landfill liquids

**\*Consult QED for higher flow requirements**

Long and Short AP4+ AutoPumps are warranted for five (5) years: 100% materials and workmanship.

Low-Drawdown AutoPumps are warranted for one (1) year: 100% materials and workmanship.

### Flow Rates<sup>1</sup>

**3/4 inch (19 mm)  
Inside Diameter Discharge Hose**  
(Equivalent to 1-Inch O.D. Tubing)

**1 inch (25.4 mm)  
Inside Diameter Discharge Hose**  
(Equivalent to 1.25-Inch O.D. Tubing)

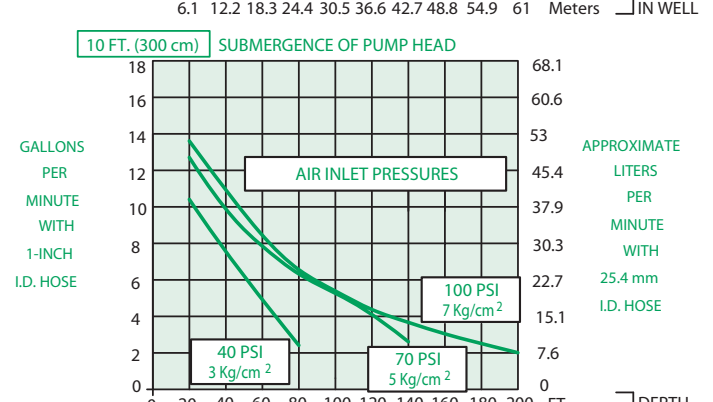
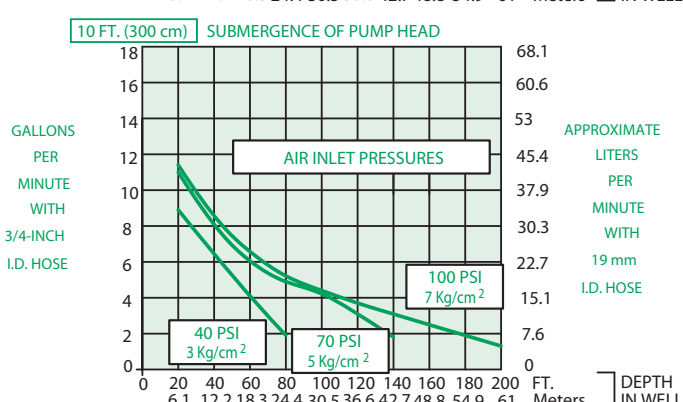
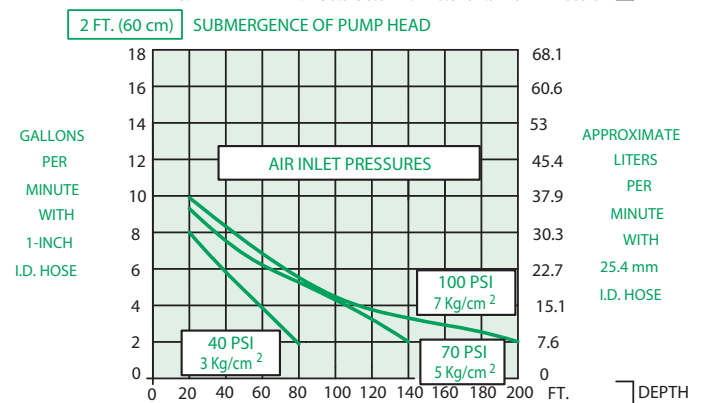
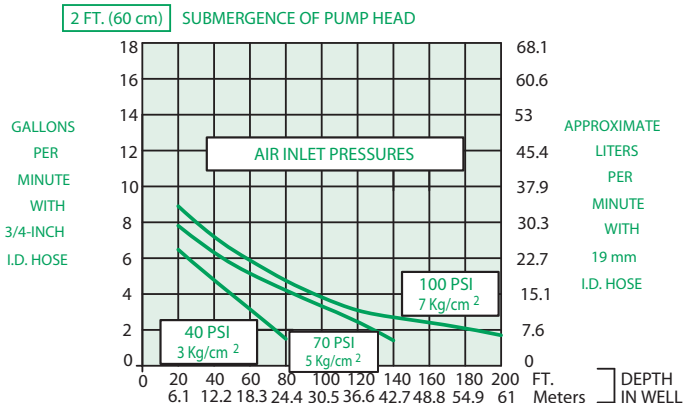
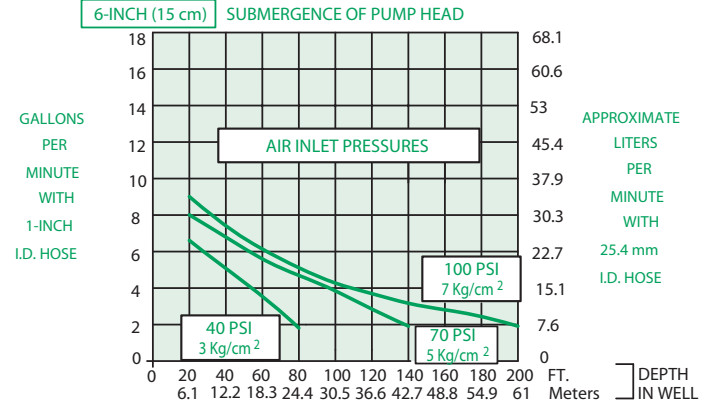
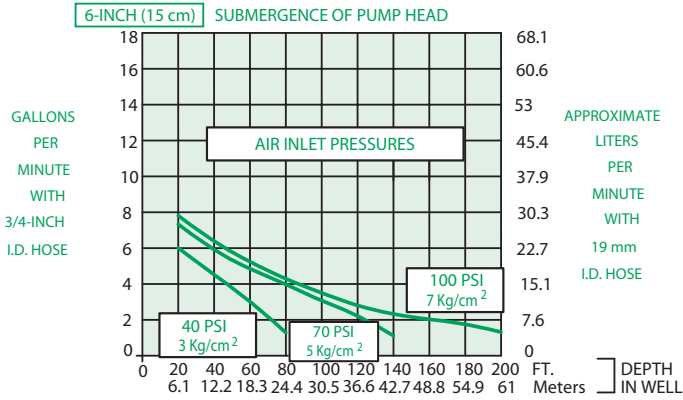

<sup>1</sup>FLOW RATES MAY VARY WITH SITE CONDITIONS. CALL QED FOR TECHNICAL ASSISTANCE.



### Air Consumption

STANDARD  
CUBIC FEET OF AIR  
PER  
GALLON PUMPED  
(SCF/GAL)

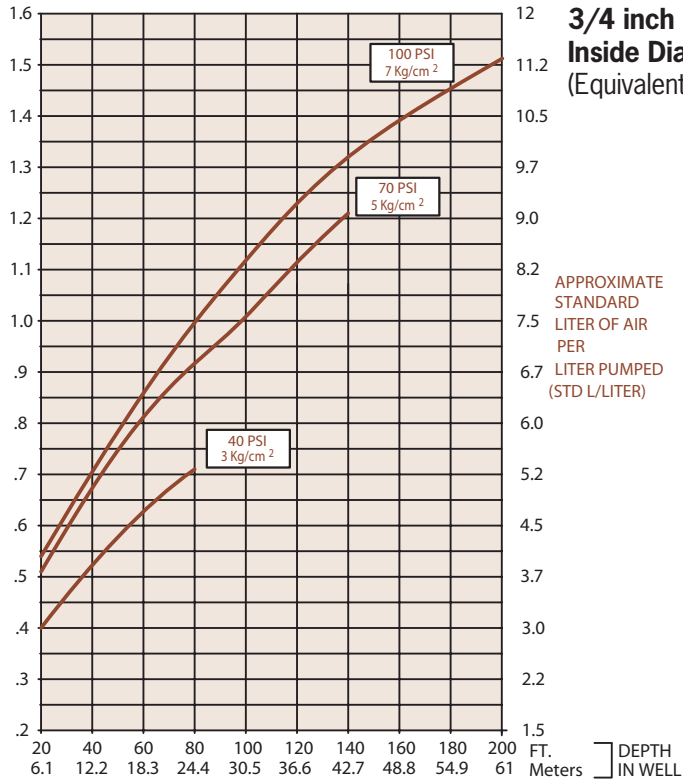

**3/4 inch (19 mm)**  
**Inside Diameter Discharge Hose**  
(Equivalent to 1-Inch O.D. Tubing)

APPROXIMATE  
STANDARD  
LITER OF AIR  
PER  
LITER PUMPED  
(STD L/LITER)

STANDARD  
CUBIC FEET OF AIR  
PER  
GALLON PUMPED  
(SCF/GAL)

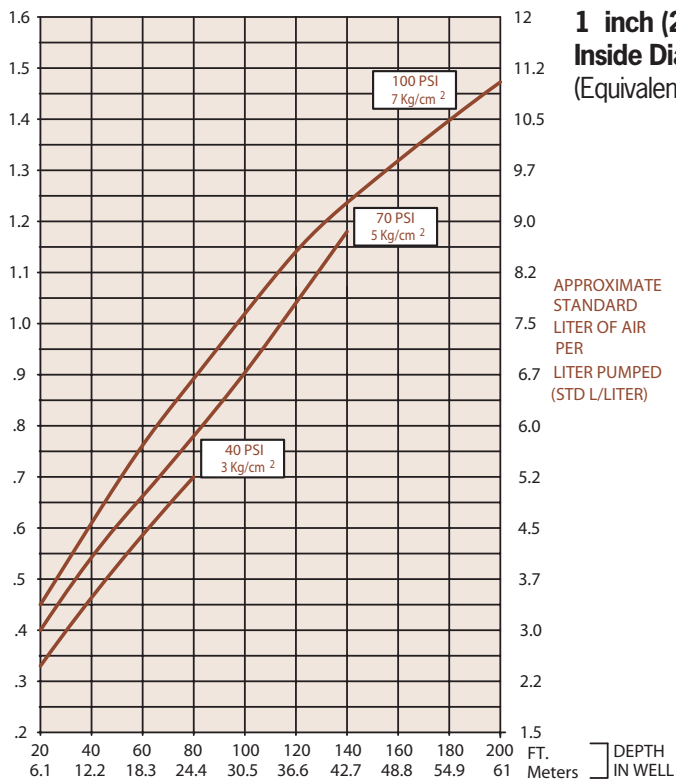

**1 inch (25.4 mm)**  
**Inside Diameter Discharge Hose**  
(Equivalent to 1.25-Inch O.D. Tubing)

APPROXIMATE  
STANDARD  
LITER OF AIR  
PER  
LITER PUMPED  
(STD L/LITER)

**Max. Flow** 7.0 gpm (26.5 lpm)

**O.D.** 3.6 in. (9.1 cm)

**Length** 27.5 in. (70 cm)



### Description

The AP4+ Low-Drawdown Bottom Inlet AutoPump provides maximum capabilities and flow in a bottom inlet pump for 4" (100 mm) diameter and larger wells with very short water columns and/or the need to pump down to as low as 15.3" (39 cm) above the bottom. It is offered in optional versions to handle even the most severe remediation and landfill pumping applications, and delivers flow rates up to 7 gpm (26.5 lpm). The AP4+ Low Drawdown Bottom Inlet AutoPump is complemented by the most comprehensive selection of accessories to provide a complete system to meet site specific requirements. Call QED for prompt, no-obligation assistance on your pumping project needs.

### The AutoPump Heritage

The AP4+ Low-Drawdown Bottom Inlet AutoPump is part of the famous AutoPump family of original automatic air-powered pumps, developed in the mid 1980s specifically to handle unique pumping needs at remediation and landfill sites. Over the years they've proven their durability at thousands of sites worldwide. AutoPumps are designed to handle difficult pumping challenges that other pumps can't, such as hydrocarbons, solvents, suspended solids, corrosives, temperature extremes, viscous fluids and frequent start/stop cycles. Beyond just the pump, AutoPump systems offer the most complete range of tubing, hose, connectors, wellhead caps and accessories to help your installation go smoothly. This superior pumping heritage, application experience and support back up every AutoPump you put to work on your project.

### Advantages

1. **The original automatic air-powered well pump, proven worldwide over 25 years**
2. **The highest flow rates and deepest pumping capabilities in the industry in a low drawdown bottom-fill pump**
3. **Patented, proven design for superior reliability and durability, even in severe applications**
4. **Handles solids, solvents, hydrocarbons corrosive conditions, viscous fluids and high temperatures beyond the limits of electric pumps**
5. **One-year warranty**



### Pump Dimensions

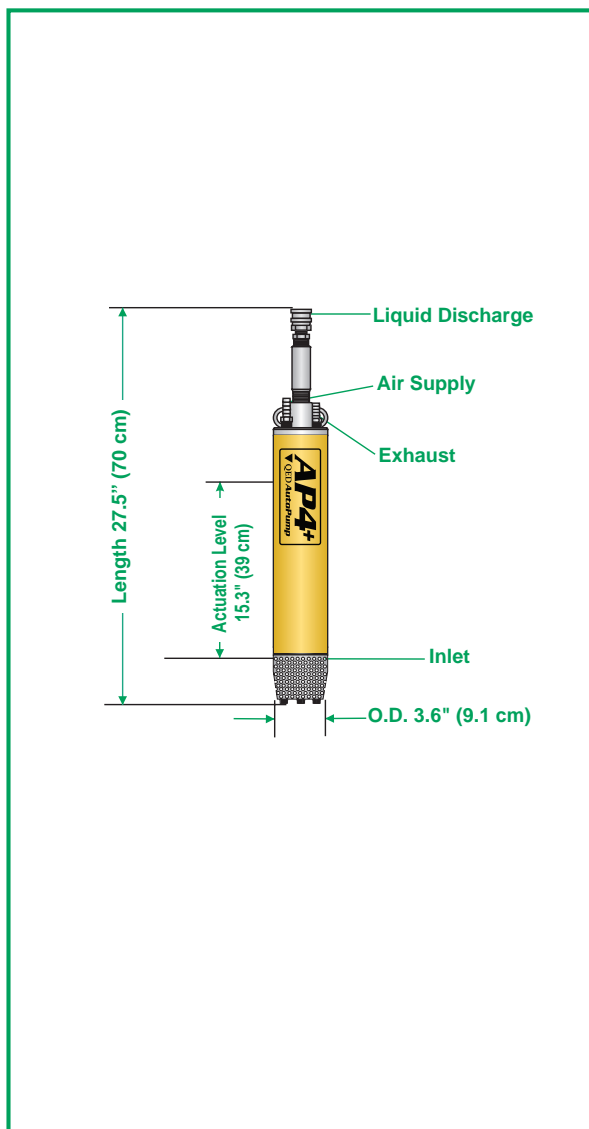

### Specifications & Operating Requirements

<b>Model</b>	<b>4" - Low-Drawdown AP4+ Bottom Inlet</b>
<b>Liquid Inlet Location</b>	Bottom ( standard plug type check valve)
<b>OD</b>	3.6 in. (9.1 cm)
<b>Length Overall (pump &amp; fittings)</b>	27.5 in. (70 cm)
<b>Weight</b>	11 lbs. (5.0 kg)
<b>Max. Flow Rate</b>	7 gpm (26.5 lpm)
<b>Pump Volume / Cycle</b>	0.11 - 0.16 gal (.42 - .61L)
<b>Max. Depth</b>	250 ft. (76 m)
<b>Air Pressure Range</b>	5 - 120 psi (0.4 - 8.4 kg/cm <sup>2</sup> )
<b>Min. Actuation Level</b>	15.3 in. (39 cm)
<b>Air Usage</b>	.32 - 2.86 scf/gal (2.2 - 21.5 liters of air/fluid liter) See Air Usage Chart
<b>Min. Liquid Density</b>	0.7 SpG (0.7 g/cm <sup>3</sup> )
<b>Standard Construction Materials<sup>1</sup></b>	
<b>Pump Body</b>	Fiberglass or Stainless Steel
<b>Pump Ends</b>	Stainless Steel
<b>Internal Components</b>	Stainless Steel, Viton, PVDF <sup>3</sup>
<b>Tube &amp; Hose Fittings</b>	Brass or Stainless Steel
<b>Fitting Type</b>	Barbs or Quick Connects
<b>Tube &amp; Hose Options</b>	
<b>Tubing Material<sup>2</sup></b>	Nylon
<b>Sizes - Liquid Discharge</b>	1 in. (25 mm) or 1-1/4 in. (32 mm) OD
<b>Pump Air Supply</b>	1/2 in. (13 mm) OD
<b>Air Exhaust</b>	5/8 in. (16 mm) OD
<b>Hose Material</b>	Nitrile
<b>Sizes - Liquid Discharge</b>	3/4 in. (19 mm) or 1 in. (25 mm) ID
<b>Pump Air Supply</b>	3/8 in. (9.5 mm) ID
<b>Air Exhaust</b>	1/2 in. (13 mm) ID

<sup>1</sup>Material upgrades available  
<sup>2</sup>Applies to QED supplied tubing;  
 other tubing sources may not  
 conform to QED fittings.

<sup>3</sup> PVDF - Polyvinylidene Fluoride

### Application Limits (Base model)

AP4+ AutoPumps are designed to handle the application ranges described below. For applications outside these ranges, consult QED about AP4 upgrades.

Maximum Temperature: 180°F (82°C)

pH Range: 4-9

Solvents and Fuels: diesel, gasoline, JP1-JP6,  
 #2 heating oils, BTEX, MTBE, landfill liquids

Low-Drawdown AutoPumps are warranted for one (1) year:  
 100% materials and workmanship.

### Flow Rates<sup>1</sup>

**3/4 inch (19 mm)  
Inside Diameter Discharge Hose  
(Equivalent to 1-Inch O.D. Tubing)**

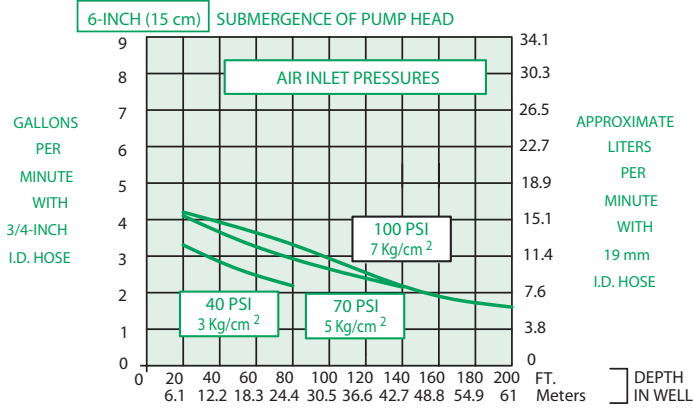

**1 inch (25.4 mm)  
Inside Diameter Discharge Hose  
(Equivalent to 1.25-Inch O.D. Tubing)**

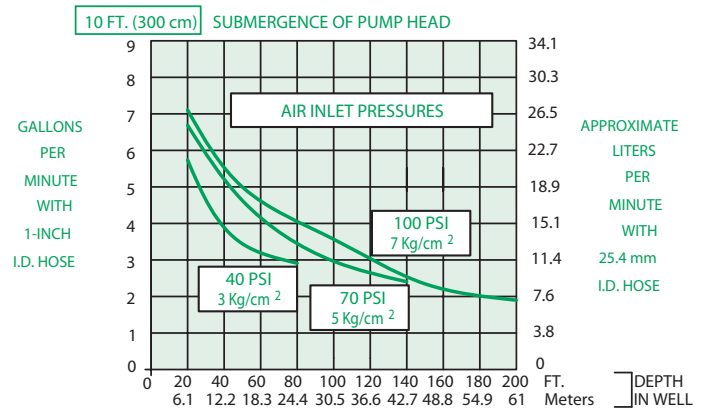
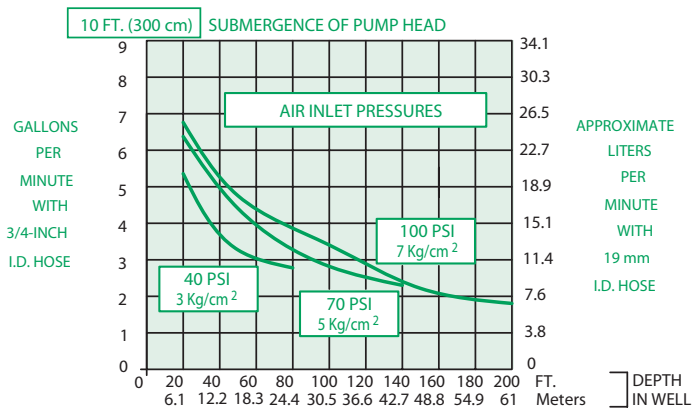
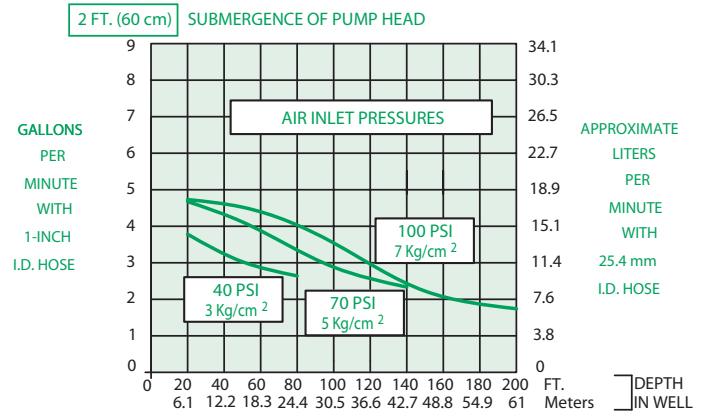
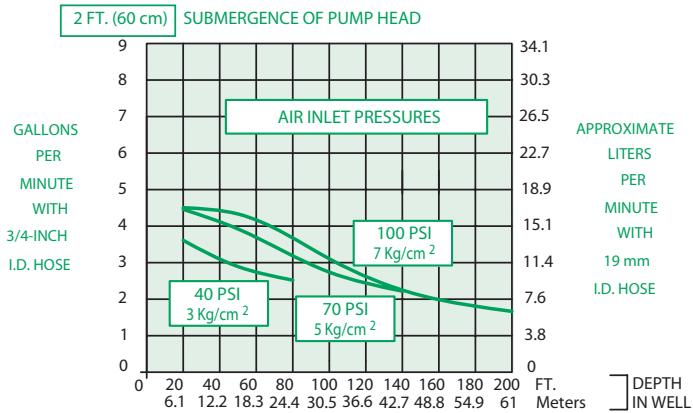
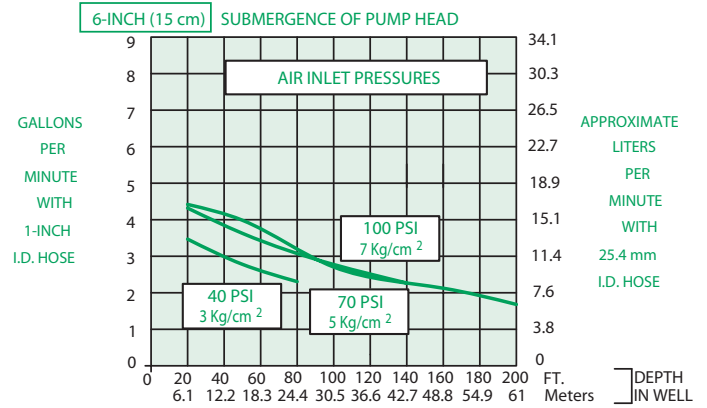

<sup>1</sup>FLOW RATES MAY VARY WITH SITE CONDITIONS. CALL QED FOR TECHNICAL ASSISTANCE.

### Air Consumption



STANDARD  
CUBIC FEET OF AIR  
PER  
GALLON PUMPED  
(SCF/GAL)

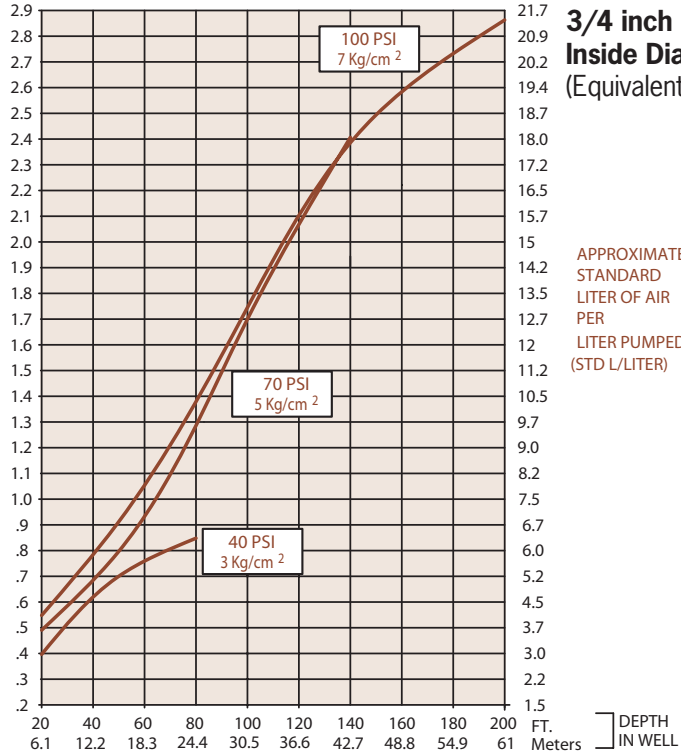

**3/4 inch (19 mm)**  
**Inside Diameter Discharge Hose**  
(Equivalent to 1-Inch O.D. Tubing)

APPROXIMATE  
STANDARD  
LITER OF AIR  
PER  
LITER PUMPED  
(STD L/LITER)

STANDARD  
CUBIC FEET OF AIR  
PER  
GALLON PUMPED  
(SCF/GAL)

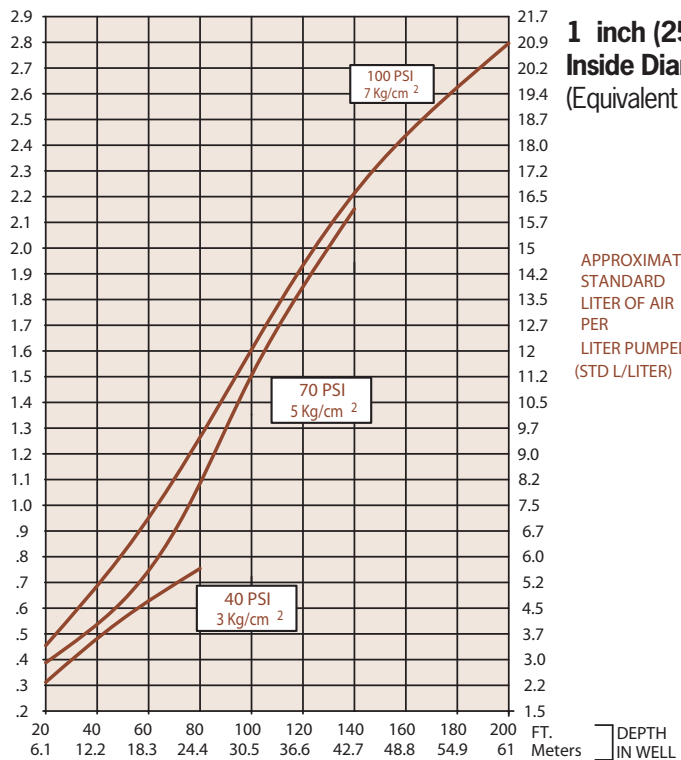

**1 inch (25.4 mm)**  
**Inside Diameter Discharge Hose**  
(Equivalent to 1.25-Inch O.D. Tubing)

APPROXIMATE  
STANDARD  
LITER OF AIR  
PER  
LITER PUMPED  
(STD L/LITER)

# AP4+T

# AutoPump®

## Top Inlet, Long

**Max. Flow** 10 gpm (38 lpm)

**O.D.** 3.6 in. (9.1 cm)

**Length** 56.7 in. (144 cm)



### Description

The AP4+ Top Inlet Long AutoPump provides maximum capabilities and flow in a top inlet pump for 4" diameter and larger wells needing an elevated inlet, such as pumping total fluids from wells contaminated with LNAPLs. It is offered in optional versions to handle even the most severe remediation and landfill pumping applications, and delivers flow rates up to 10 gpm\*. The AP4+ Long Top Inlet AutoPump is complemented by the most comprehensive selection of accessories to provide a complete system to meet site-specific requirements. Call QED for prompt, no-obligation assistance on your pumping project needs.

### The AutoPump Heritage

The AP4+ Top Inlet Long AutoPump is part of the famous AutoPump family of original automatic air-powered pumps, developed in the mid 1980s specifically to handle unique pumping needs at remediation and landfill sites. Over the years they've proven their durability at thousands of sites worldwide. AutoPumps are designed to handle difficult pumping challenges that other pumps can't, such as hydrocarbons, solvents, suspended solids, corrosives, temperature extremes, viscous fluids and frequent start/stop cycles. Beyond just the pump, AutoPump systems offer the most complete range of tubing, hose, connectors, wellhead caps and accessories to help your installation go smoothly. This superior pumping heritage, application experience and support back up every AutoPump you put to work on your project.

### Advantages

1. The original automatic air-powered well pump, proven worldwide over 25 years
2. The highest flow rates and deepest pumping capabilities in the industry
3. Patented, proven design for superior reliability and durability, even in severe applications
4. Handles solids, solvents, hydrocarbons corrosive conditions, viscous fluids and high temperatures beyond the limits of electric pumps
5. Five-year warranty

\*Consult QED for higher flow requirements



### Pump Dimensions

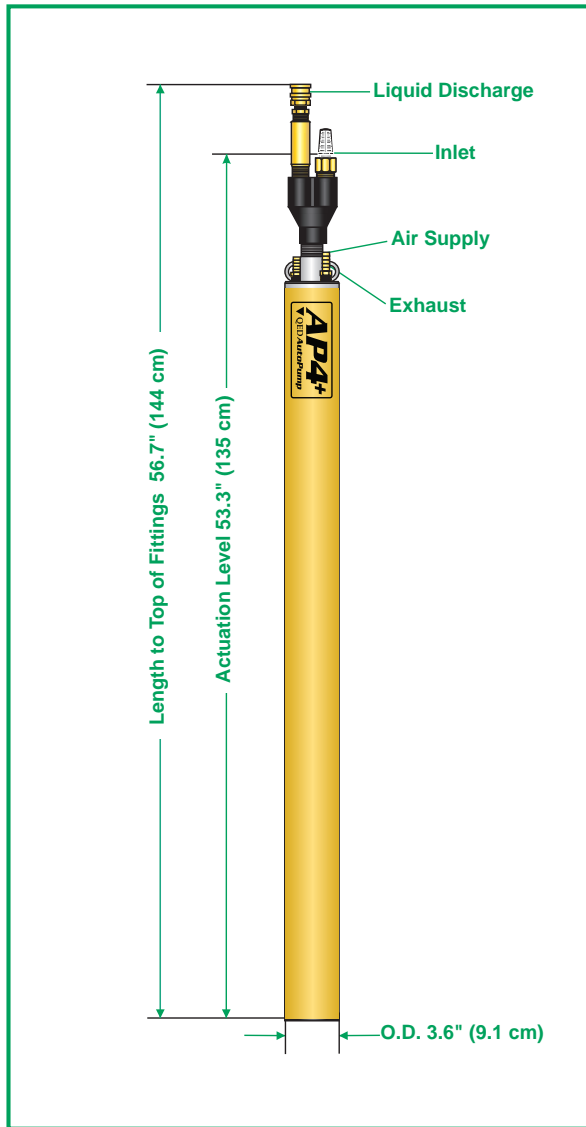

### Specifications & Operating Requirements

<b>Model</b>	<b>4" - Long AP4+ Top Inlet</b>
<b>Liquid Inlet Location</b>	Top
<b>OD</b>	3.6 in. (9.1 cm)
<b>Length Overall (pump &amp; fittings)</b>	56.7 in. (144 cm)
<b>Weight</b>	18 lbs. (8.7 kg)
<b>Max. Flow Rate</b>	10 gpm (38 lpm) - See Flow Rate Chart
<b>Pump Volume / Cycle</b>	0.58 - 0.78 gal (2.2 - 3.0L)
<b>Min. Actuation Level</b>	53.3 in. (135 cm)
<b>Standard Pump</b>	
<b>Max. Depth</b>	250 ft. (76 m)
<b>Air Pressure Range</b>	5 - 120 psi (0.4 - 8.4 kg/cm <sup>2</sup> )
<b>Air Usage</b>	0.35-1.1 scf / gal. (3.0-8.4 liters of air / fluid liter)
<b>High Pressure Pump</b>	
<b>Max. Depth</b>	425 ft. (130 m)
<b>Air Pressure Range</b>	5 - 200 psi (0.4 - 14.1 kg/cm <sup>2</sup> )
<b>Min. Liquid Density</b>	
	0.7 SpG (0.7 g/cm <sup>3</sup> )
<b>Standard Construction Materials<sup>1</sup></b>	
<b>Pump Body</b>	Fiberglass or Stainless Steel
<b>Pump Ends</b>	Stainless Steel, Acetal
<b>Internal Components</b>	Stainless Steel, Viton, Acetal, PVDF <sup>3</sup>
<b>Tube &amp; Hose Fittings</b>	Brass or Stainless Steel
<b>Fitting Type</b>	Barbs or Quick Connects
<b>Tube &amp; Hose Options</b>	
<b>Tubing Material<sup>2</sup></b>	Nylon
<b>Sizes - Liquid Discharge</b>	1 in. (25 mm) or 1-1/4 in. (32 mm) OD
<b>Pump Air Supply</b>	1/2 in. (13 mm) OD
<b>Air Exhaust</b>	5/8 in. (16 mm) OD
<b>Hose Material</b>	Nitrile
<b>Sizes - Liquid Discharge</b>	3/4 in. (19 mm) or 1 in. (25 mm) ID
<b>Pump Air Supply</b>	3/8 in. (9.5 mm) ID
<b>Air Exhaust</b>	1/2 in. (13 mm) ID

<sup>1</sup> Material upgrades available  
<sup>2</sup> Applies to QED supplied tubing;  
 other tubing sources may not  
 conform to QED fittings.

<sup>3</sup> PVDF - Polyvinylidene Fluoride

### Standard Application Limits (standard model)

AP4+ AutoPumps are designed to handle the application ranges described below. For applications outside these ranges, consult QED.

Maximum Temperature: 150°F (65°C)

pH Range: 4-9

Solvents and Fuels: diesel, gasoline, JP1-JP6,  
 #2 heating oils, BTEX, MTBE, landfill liquids

Long and Short AP4+ AutoPumps are warranted for five (5) years: 100% materials and workmanship.

Low-Drawdown AutoPumps are warranted for one (1) year: 100% materials and workmanship.

### Flow Rates<sup>1</sup>

**3/4 inch (19 mm)  
Inside Diameter Discharge Hose  
(Equivalent to 1-Inch O.D. Tubing)**

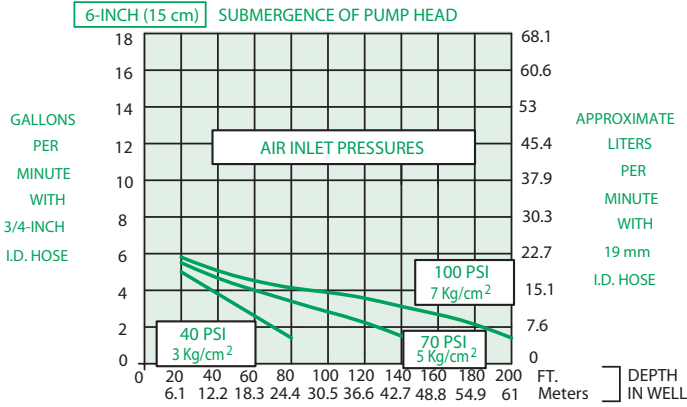

**1 inch (25.4 mm)  
Inside Diameter Discharge Hose  
(Equivalent to 1.25-Inch O.D. Tubing)**

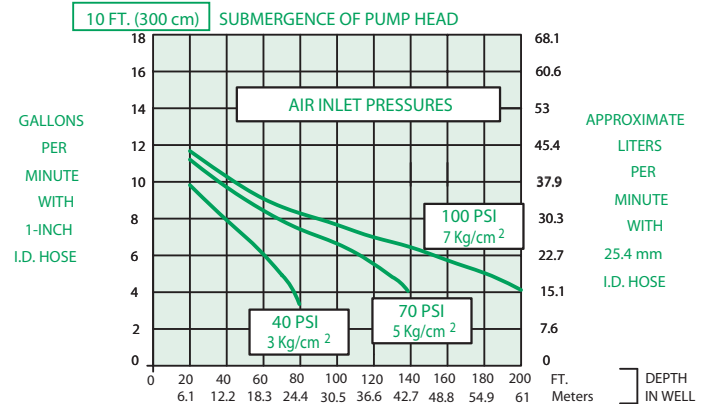
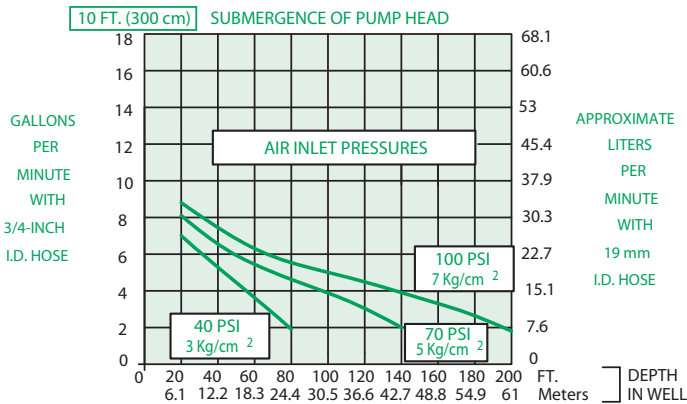
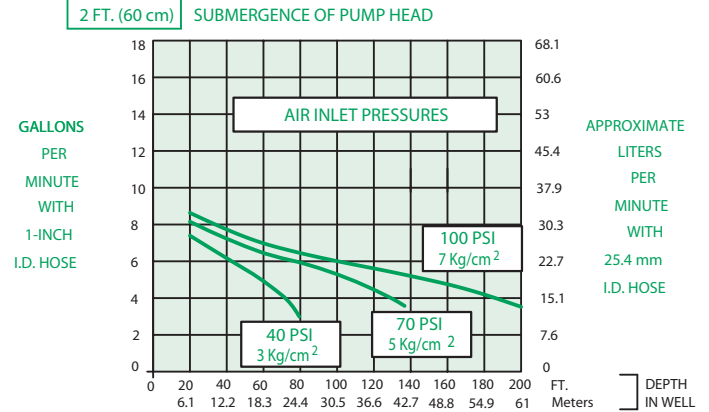
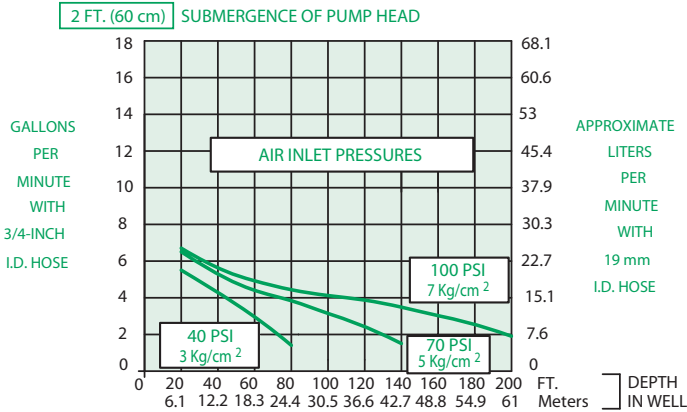
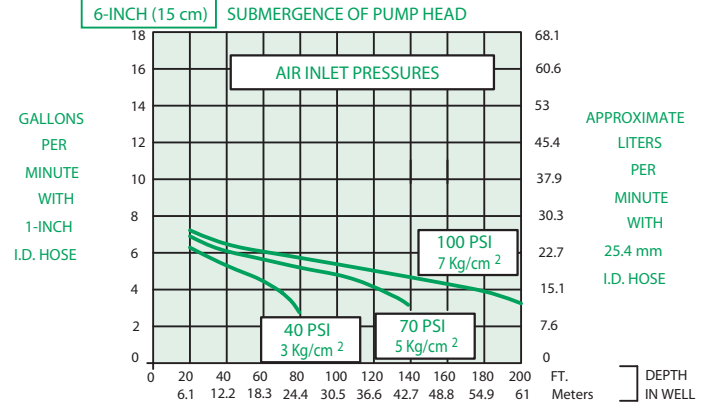

<sup>1</sup>FLOW RATES MAY VARY WITH SITE CONDITIONS. CALL QED FOR TECHNICAL ASSISTANCE.



### Air Consumption

STANDARD  
CUBIC FEET OF AIR  
PER  
GALLON PUMPED  
(SCF/GAL)

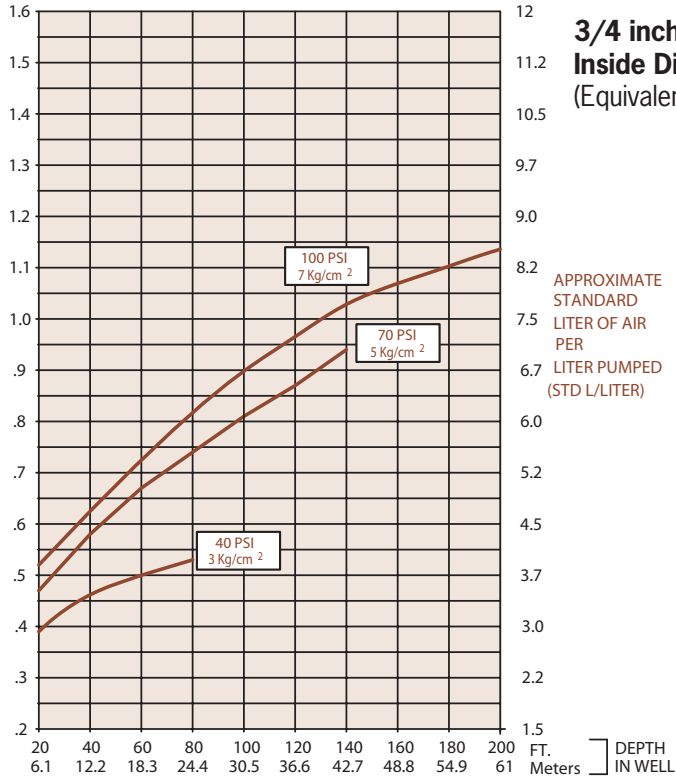

APPROXIMATE  
STANDARD  
LITER OF AIR  
PER  
LITER PUMPED  
(STD L/LITER)

STANDARD  
CUBIC FEET OF AIR  
PER  
GALLON PUMPED  
(SCF/GAL)

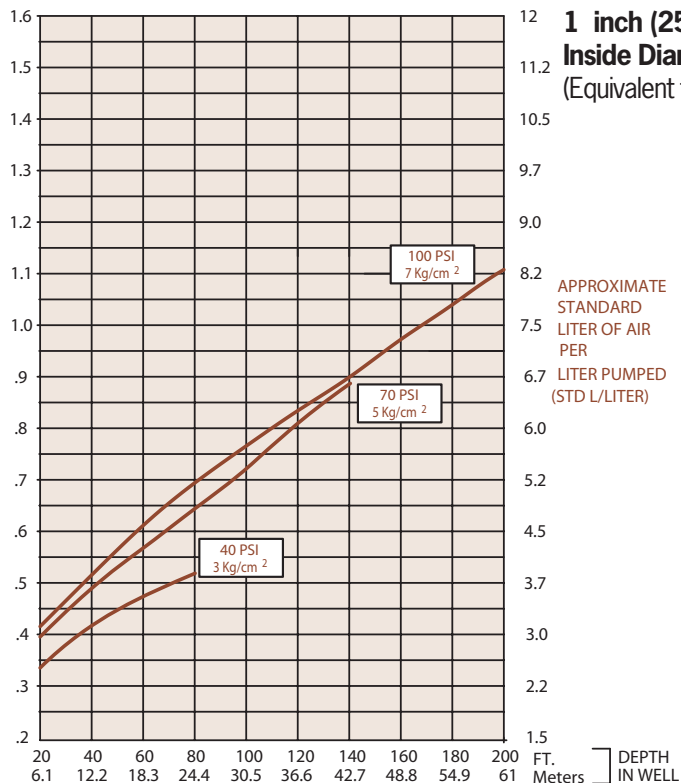

APPROXIMATE  
STANDARD  
LITER OF AIR  
PER  
LITER PUMPED  
(STD L/LITER)

# AP4+T

# AutoPump®

## Top Inlet, Short

**Max. Flow** 9 gpm (34 lpm)

**O.D.** 3.6 in. (9.1 cm)

**Length** 45 in. (110 cm)

### Description

The AP4+ Top Inlet Short AutoPump provides maximum capabilities and flow in a top inlet pump for 4" (100 mm) diameter and larger wells with shorter water columns and the need for an elevated inlet, such as pumping total fluids from wells contaminated with LNAPLs. It is offered in optional versions to handle even the most severe remediation and landfill pumping applications, and delivers flow rates up to 9 gpm (34 lpm)\*. The AP4+ Short Top Inlet AutoPump is complemented by the most comprehensive selection of accessories to provide a complete system to meet site-specific requirements. Call QED for prompt, no-obligation assistance on your pumping project needs.

### The AutoPump Heritage

The AP4+ Top Inlet Short AutoPump is part of the famous AutoPump family of original automatic air-powered pumps, developed in the mid 1980s specifically to handle unique pumping needs at remediation and landfill sites. Over the years they've proven their durability at thousands of sites worldwide. AutoPumps are designed to handle difficult pumping challenges that other pumps can't, such as hydrocarbons, solvents, suspended solids, corrosives, temperature extremes, viscous fluids and frequent start/stop cycles. Beyond just the pump, AutoPump systems offer the most complete range of tubing, hose, connectors, wellhead caps and accessories to help your installation go smoothly. This superior pumping heritage, application experience and support back up every AutoPump you put to work on your project.



### Advantages

1. The original automatic air-powered well pump, proven worldwide over 25 years
2. The highest flow rates and deepest pumping capabilities in the industry
3. Patented, proven design for superior reliability and durability, even in severe applications
4. Handles solids, solvents, hydrocarbons corrosive conditions, viscous fluids and high temperatures beyond the limits of electric pumps
5. Five-year warranty

\*Consult QED for higher flow requirements



### Pump Dimensions

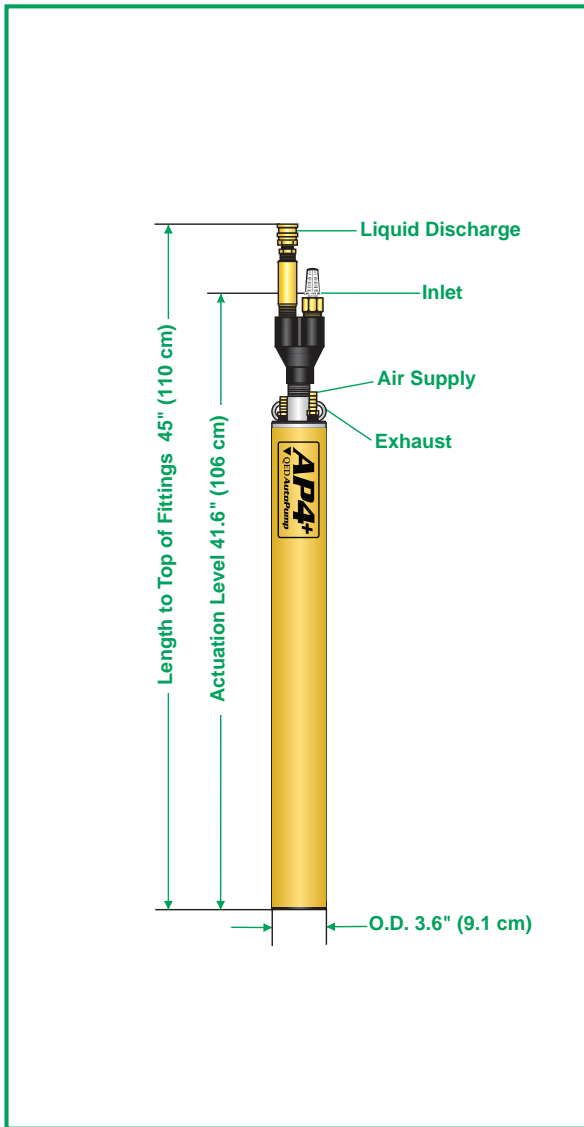

### Specifications & Operating Requirements

<b>Model</b>	<b>4" - Short AP4+ Top Inlet</b>
<b>Liquid Inlet Location</b>	Top
<b>OD</b>	3.6 in. (9.1 cm)
<b>Length Overall (pump &amp; fittings)</b>	45 in. (110 cm)
<b>Weight</b>	17 lbs. (7.8 kg)
<b>Max. Flow Rate</b>	9 gpm (34 lpm) - See Flow Rate Chart
<b>Pump Volume / Cycle</b>	0.22 - 0.36 gal (.83 - 1.36L)
<b>Min. Actuation Level</b>	41.6 in. (106 cm)
<b>Standard Pump</b>	
<b>Max. Depth</b>	250 ft. (76 m)
<b>Air Pressure Range</b>	5 - 120 psi (0.4 - 8.4 kg/cm <sup>2</sup> )
<b>Air Usage</b>	0.35-1.5 scf / gal. (2.4-11.3 liters of air / fluid liter) - See Air Usage Chart
<b>High Pressure Pump</b>	
<b>Max. Depth</b>	425 ft. (130 m)
<b>Air Pressure Range</b>	5 - 200 psi (0.4 - 14.1 kg/cm <sup>2</sup> )
<b>Min. Liquid Density</b>	0.7 SpG (0.7 g/cm <sup>3</sup> )
<b>Standard Construction Materials<sup>1</sup></b>	
<b>Pump Body</b>	Fiberglass or Stainless Steel
<b>Pump Ends</b>	Stainless Steel, Acetal
<b>Internal Components</b>	Stainless Steel, Viton, Acetal, PVDF <sup>3</sup>
<b>Tube &amp; Hose Fittings</b>	Brass or Stainless Steel
<b>Fitting Type</b>	Barbs or Quick Connects
<b>Tube &amp; Hose Options</b>	
<b>Tubing Material<sup>2</sup></b>	Nylon
<b>Sizes - Liquid Discharge</b>	1 in. (25 mm) or 1-1/4 in. (32 mm) OD
<b>Pump Air Supply</b>	1/2 in. (13 mm) OD
<b>Air Exhaust</b>	5/8 in. (16 mm) OD
<b>Hose Material</b>	Nitrile
<b>Sizes - Liquid Discharge</b>	3/4 in. (19 mm) or 1 in. (25 mm) ID
<b>Pump Air Supply</b>	3/8 in. (9.5 mm) ID
<b>Air Exhaust</b>	1/2 in. (13 mm) ID

<sup>1</sup> Material upgrades available  
<sup>2</sup> Applies to QED supplied tubing;  
 other tubing sources may not  
 conform to QED fittings.

<sup>3</sup> PVDF - Polyvinylidene Fluoride

### Standard Application Limits (standard model)

AP4+ AutoPumps are designed to handle the application ranges described below. For applications outside these ranges, consult QED.

Maximum Temperature: 150°F (65°C)

pH Range: 4-9

Solvents and Fuels: diesel, gasoline, JP1-JP6,  
 #2 heating oils, BTEX, MTBE, landfill liquids

Long and Short AP4+ AutoPumps are warranted for five (5) years: 100% materials and workmanship.

Low-Drawdown AutoPumps are warranted for one (1) year: 100% materials and workmanship.

### Flow Rates<sup>1</sup>

**3/4 inch (19 mm)  
Inside Diameter Discharge Hose  
(Equivalent to 1-Inch O.D. Tubing)**

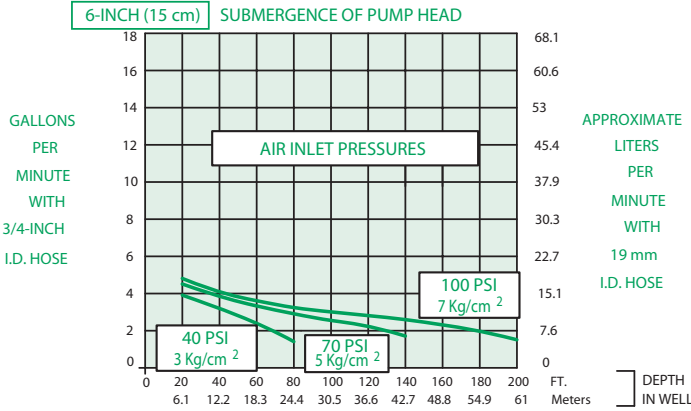

**1 inch (25.4 mm)  
Inside Diameter Discharge Hose  
(Equivalent to 1.25-Inch O.D. Tubing)**

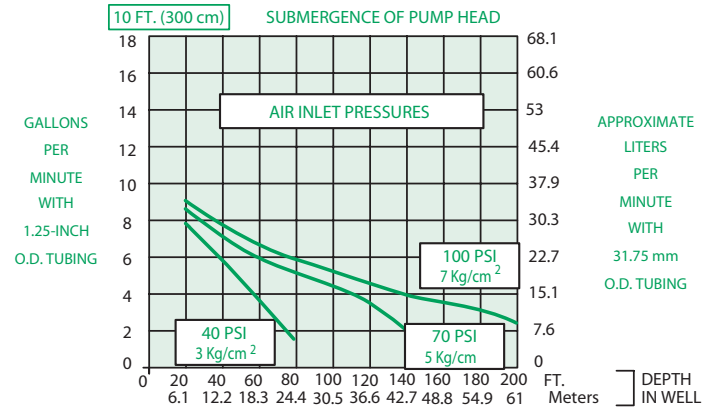
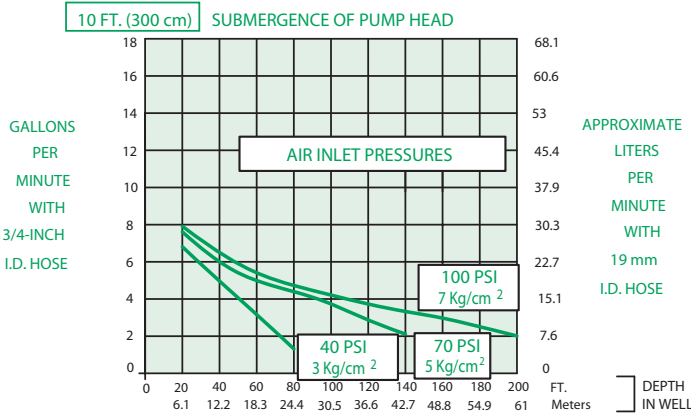
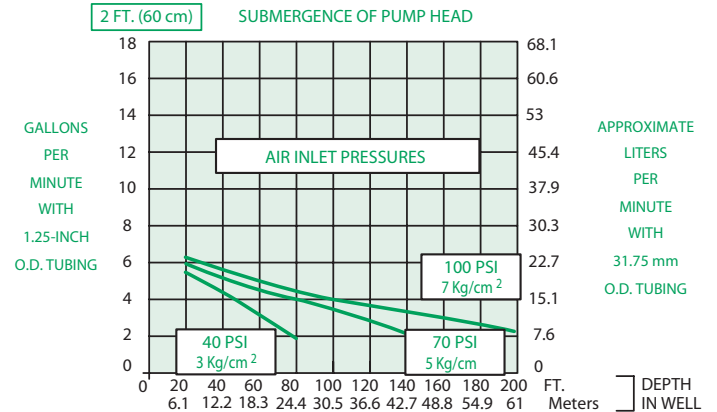
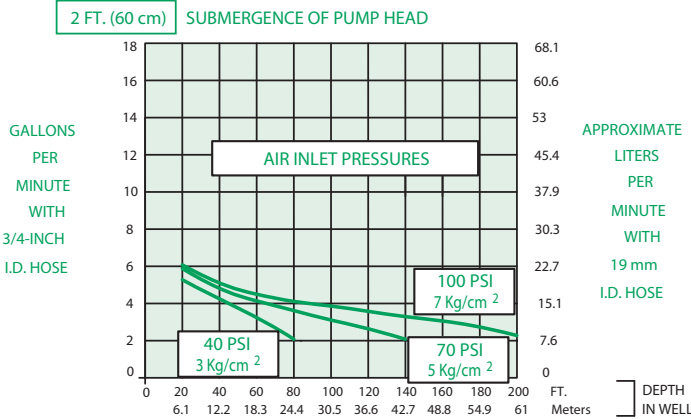
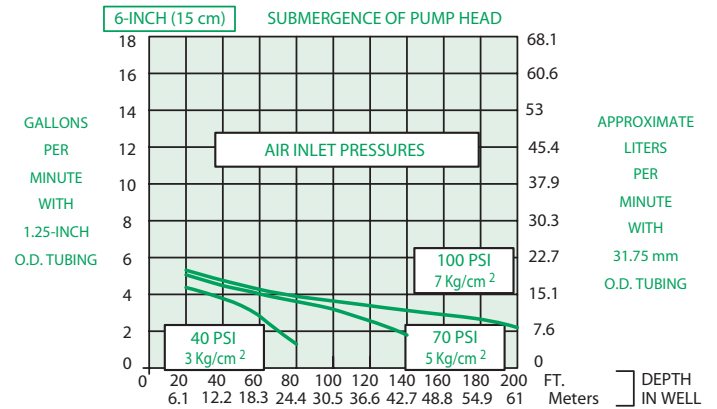

<sup>1</sup>FLOW RATES MAY VARY WITH SITE CONDITIONS. CALL QED FOR TECHNICAL ASSISTANCE.

### Air Consumption



STANDARD  
CUBIC FEET OF AIR  
PER  
GALLON PUMPED  
(SCF/GAL)

STANDARD  
CUBIC FEET OF AIR  
PER  
GALLON PUMPED  
(SCF/GAL)

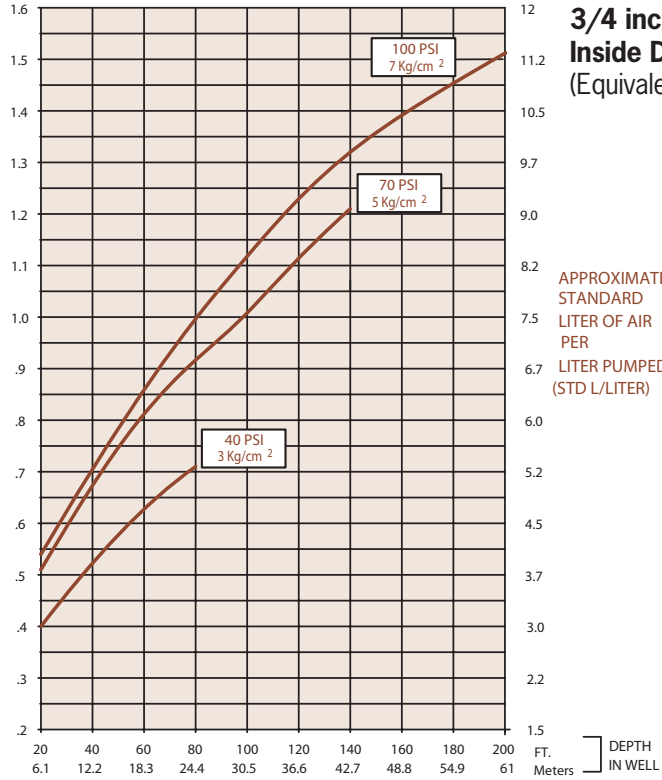

**3/4 inch (19 mm)  
Inside Diameter Discharge Hose  
(Equivalent to 1-Inch O.D. Tubing)**

APPROXIMATE  
STANDARD  
LITER OF AIR  
PER  
LITER PUMPED  
(STD L/LITER)

**1 inch (25.4 mm)  
Inside Diameter Discharge Hose  
(Equivalent to 1.25-Inch O.D. Tubing)**

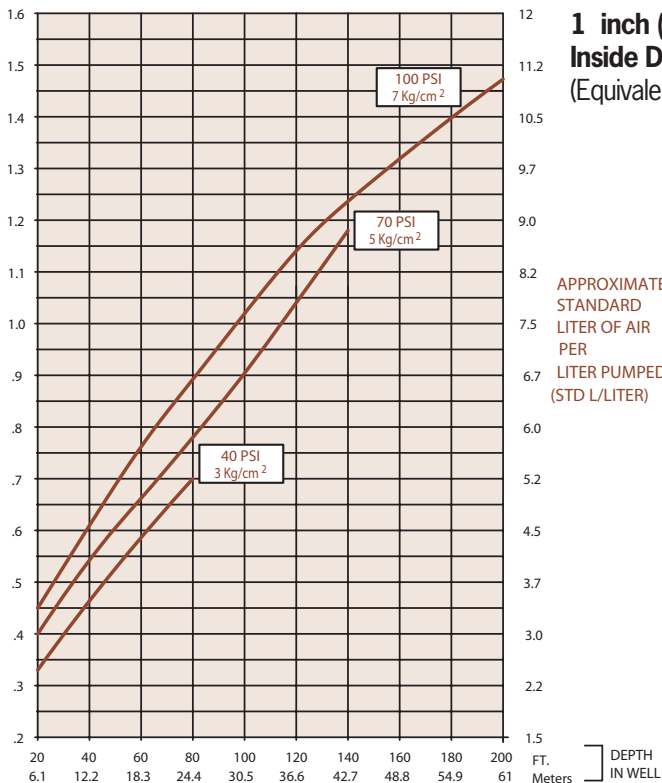

APPROXIMATE  
STANDARD  
LITER OF AIR  
PER  
LITER PUMPED  
(STD L/LITER)

**Max. Flow** 6.4 gpm (24 lpm)

**O.D.** 3.6 in. (9.1 cm)

**Length** 30.75 in. (78 cm)

### Description

The Low-Drawdown AP4+ Top Inlet AutoPump provides maximum capabilities and flow in a top inlet pump for 4" (100 mm) diameter and larger wells with very short water columns and/or the need to pump down to as low as 24" (62 cm) above the bottom. It is offered in optional versions to handle even the most severe remediation and landfill pumping applications, and delivers flow rates up to 6.4 gpm (24 lpm). The Low Drawdown AP4+ Top Inlet AutoPump is complemented by the most comprehensive selection of accessories to provide a complete system to meet site-specific requirements. Call QED for prompt, no-obligation assistance on your pumping project needs.

### The AutoPump Heritage

The Low-Drawdown AP4+ Top Inlet AutoPump is part of the famous AutoPump family of original automatic air-powered pumps, developed in the mid 1980s specifically to handle unique pumping needs at remediation and landfill sites. Over the years they've proven their durability at thousands of sites worldwide. AutoPumps are designed to handle difficult pumping challenges that other pumps can't, such as solvents, suspended solids, corrosives, temperature extremes, viscous fluids and frequent start/stop cycles. Beyond just the pump, AutoPump systems offer the most complete range of tubing, hose, connectors, caps and accessories to help your installation go smoothly. This superior pumping heritage, application experience and support back up every AutoPump you put to work on your project.



### Advantages

1. The original automatic air-powered well pump, proven worldwide over 25 years
2. The highest flow rates and deepest pumping capabilities in the industry in a low drawdown top-fill pump
3. Patented, proven design for superior reliability and durability, even in severe applications
4. Handles solids, solvents, corrosive conditions, viscous fluids and high temperatures beyond the limits of electric pumps
5. One-year warranty

### Pump Dimensions

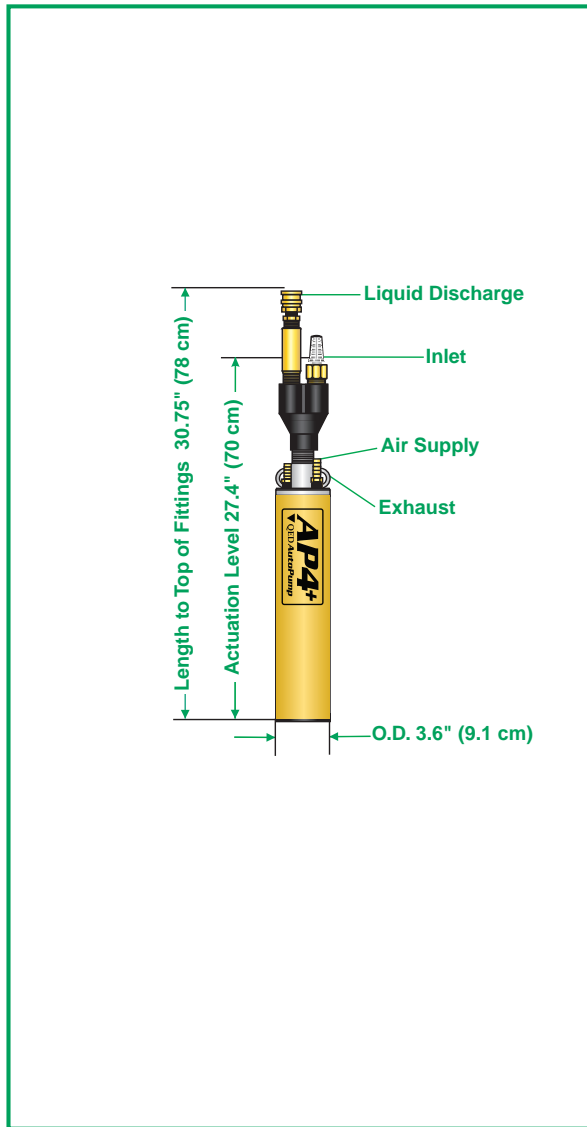

### Specifications & Operating Requirements

<b>Model</b>	<b>4" - Low-Drawdown AP4+ Top Inlet</b>
<b>Liquid Inlet Location</b>	Top
<b>OD</b>	3.6 in. (9.1 cm)
<b>Length Overall (pump &amp; fittings)</b>	30.75 in. (78 cm)
<b>Weight</b>	11 lbs. (5.0 kg)
<b>Max. Flow Rate</b>	6.4 gpm (24 lpm)
<b>Pump Volume / Cycle</b>	0.11 - 0.16 gal (.42 - .61L)
<b>Max. Depth</b>	250 ft. (76 m)
<b>Air Pressure Range</b>	5 - 120 psi (0.4 - 8.4 kg/cm <sup>2</sup> )
<b>Min. Actuation Level</b>	27.4 in. (70 cm)
<b>Air Usage</b>	.31 - 2.85 scf/gal (2.2 - 21.5 liters of air/fluid liter) see Air Usage Chart
<b>Min. Liquid Density</b>	0.7 SpG (0.7 g/cm <sup>3</sup> )
<b>Standard Construction Materials<sup>1</sup></b>	
<b>Pump Body</b>	Fiberglass or Stainless Steel
<b>Pump Ends</b>	Stainless Steel, Acetal
<b>Internal Components</b>	Stainless Steel, Viton, Acetal, PVDF <sup>3</sup>
<b>Tube &amp; Hose Fittings</b>	Brass or Stainless Steel
<b>Fitting Type</b>	Barbs or Quick Connects
<b>Tube &amp; Hose Options</b>	
<b>Tubing Material<sup>2</sup></b>	Nylon
<b>Sizes - Liquid Discharge</b>	1 in. (25 mm) or 1-1/4 in. (32 mm) OD
<b>Pump Air Supply</b>	1/2 in. (13 mm) OD
<b>Air Exhaust</b>	5/8 in. (16 mm) OD
<b>Hose Material</b>	Nitrile
<b>Sizes - Liquid Discharge</b>	3/4 in. (19 mm) or 1 in. (25 mm) ID
<b>Pump Air Supply</b>	3/8 in. (9.5 mm) ID
<b>Air Exhaust</b>	1/2 in. (13 mm) ID

<sup>1</sup> Material upgrades available  
<sup>2</sup> Applies to QED supplied tubing;  
 other tubing sources  
 may not conform to QED fittings.

<sup>3</sup> PVDF - Polyvinylidene Fluoride

### Standard Application Limits (standard model)

AP4+ AutoPumps are designed to handle the application ranges described below. For applications outside these ranges, consult QED.

Maximum Temperature: 180°F (82°C)

pH Range: 4-9

Solvents and Fuels: diesel, gasoline, JP1-JP6, #2 heating oils, BTEX, MTBE, landfill liquids

Long and Short AP4+ AutoPumps are warranted for five (5) years: 100% materials and workmanship.

Low-Drawdown AutoPumps are warranted for one (1) year: 100% materials and workmanship.

### Flow Rates<sup>1</sup>

**3/4 inch (19 mm)  
Inside Diameter Discharge Hose  
(Equivalent to 1-Inch O.D. Tubing)**

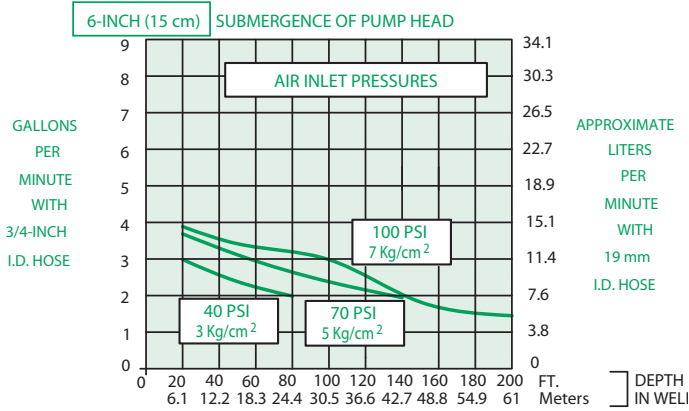

**1 inch (25.4 mm)  
Inside Diameter Discharge Hose  
(Equivalent to 1.25-Inch O.D. Tubing)**

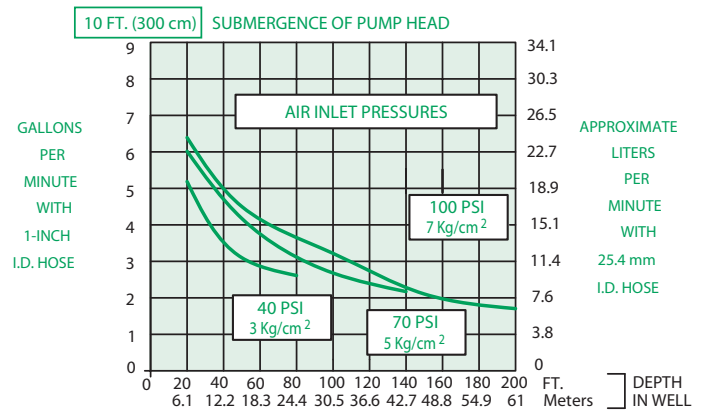
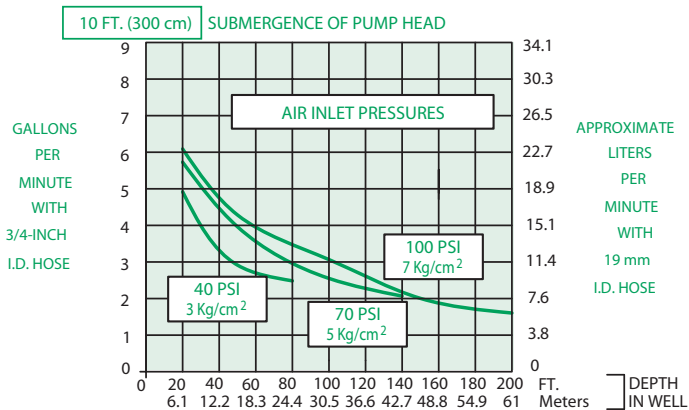
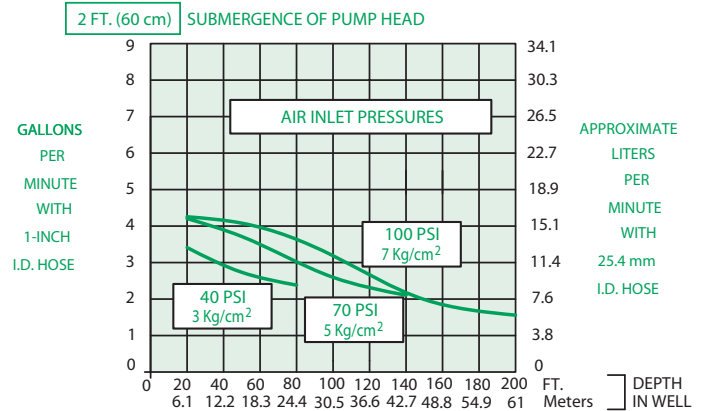
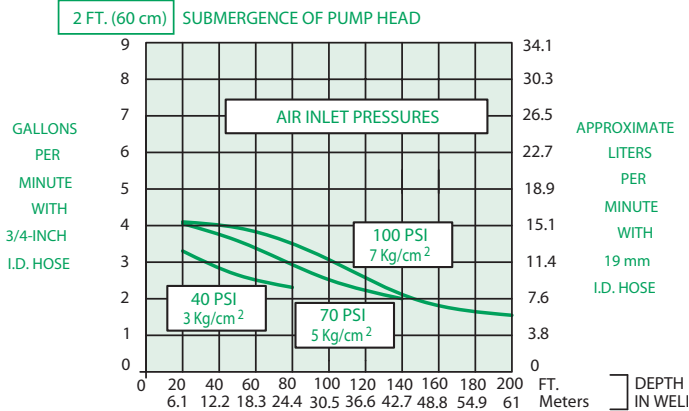
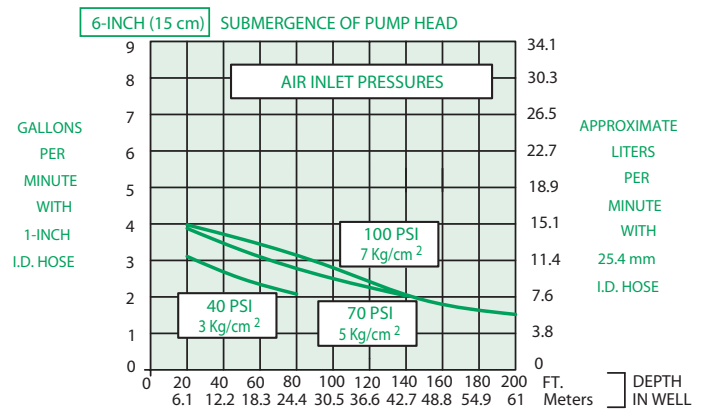

<sup>1</sup> FLOW RATES MAY VARY WITH SITE CONDITIONS. CALL QED FOR TECHNICAL ASSISTANCE.

### Air Consumption



STANDARD  
CUBIC FEET OF AIR  
PER  
GALLON PUMPED  
(SCF/GAL)

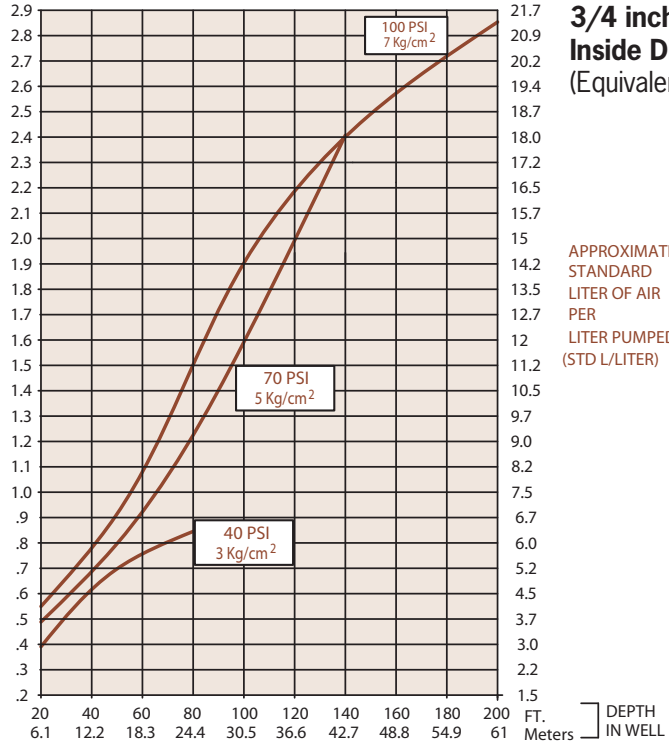

**3/4 inch (19 mm)  
Inside Diameter Discharge Hose  
(Equivalent to 1-Inch O.D. Tubing)**

APPROXIMATE  
STANDARD  
LITER OF AIR  
PER  
LITER PUMPED  
(STD L/LITER)

STANDARD  
CUBIC FEET OF AIR  
PER  
GALLON PUMPED  
(SCF/GAL)

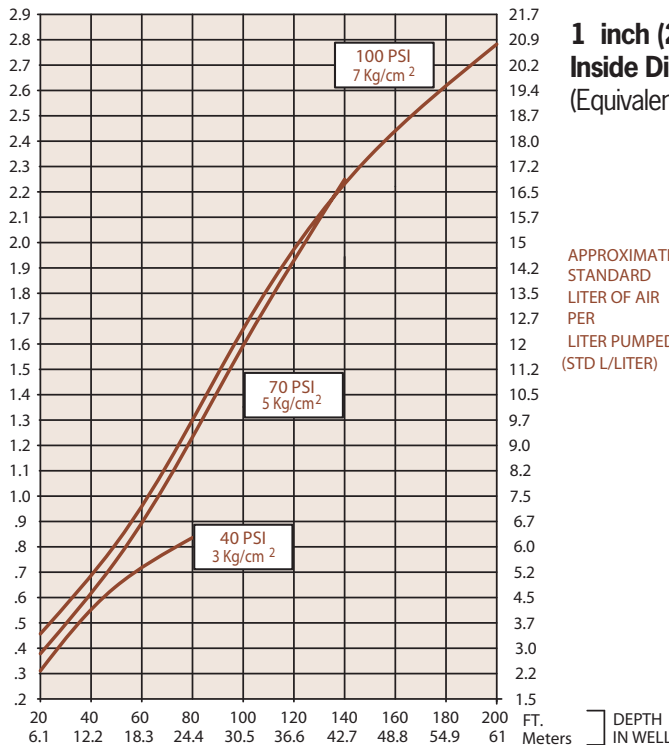

**1 inch (25.4 mm)  
Inside Diameter Discharge Hose  
(Equivalent to 1.25-Inch O.D. Tubing)**

APPROXIMATE  
STANDARD  
LITER OF AIR  
PER  
LITER PUMPED  
(STD L/LITER)

# AP3B

AutoPump®

## Bottom Inlet, Long

**Max. Flow** 7.3 gpm (27.6 lpm)

**O.D.** 2.63 in. (6.68 cm)

**Length** 52 in. (132 cm)

### Description

The AP3B Bottom Inlet Long AutoPump is designed for moderate-duty remediation pumping applications with well casings 3" (75 mm) diameter and larger. Call QED for prompt, no-obligation assistance on your pumping project needs.

### The AutoPump Heritage

The AP3B Bottom Inlet Long AutoPump is part of the famous AutoPump family of original automatic air-powered pumps, developed in the mid 1980s specifically to handle unique pumping needs at remediation and landfill sites. Over the years they've proven their durability at thousands of sites worldwide. AutoPumps are designed to handle difficult pumping challenges that other pumps can't, such as solvents, suspended solids, corrosives, temperature extremes, viscous fluids and frequent start/stop cycles. Beyond just the pump, AutoPump systems offer the most complete range of tubing, hose, connectors, caps and accessories to help your installation go smoothly. This superior pumping heritage, application experience and support back up every AutoPump you put to work on your project.



### Advantages

1. Based on the original automatic air-powered well pump, proven worldwide over 25 years
2. Competitive flow rates and pumping capabilities
3. Patented, proven design for superior reliability and durability
4. Handles solids, some solvents, hydrocarbons and corrosive conditions beyond the limits of electric pumps
5. Two-year warranty



### Pump Dimensions

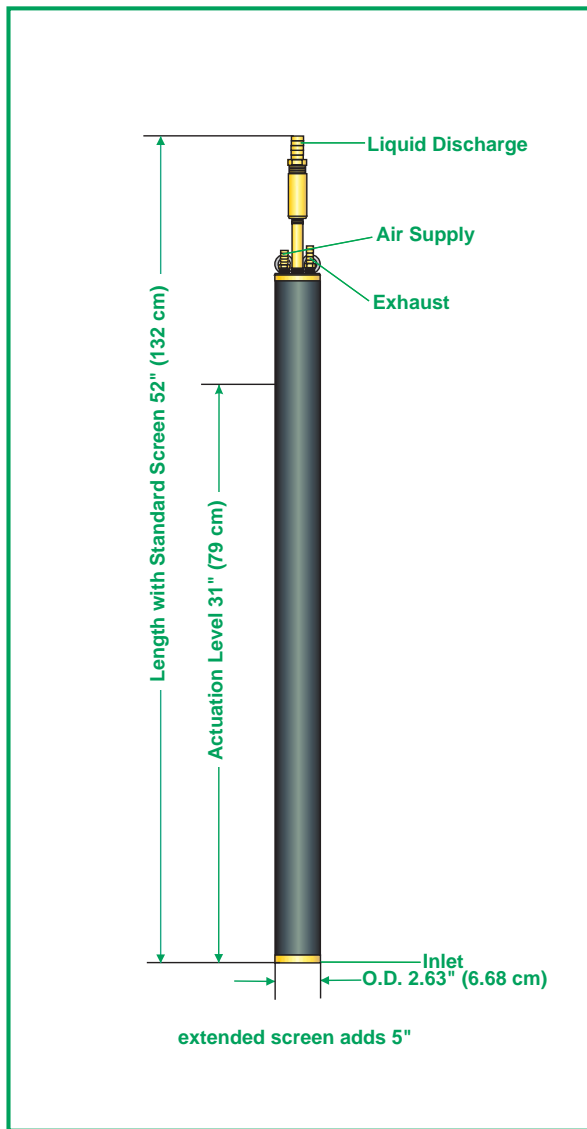

### Specifications & Operating Requirements

<b>Model</b>	<b>3" - Long AP3 Bottom Inlet</b>
<b>Liquid Inlet Location</b>	Bottom
<b>OD</b>	2.63 in. (6.68 cm)
<b>Length Overall (pump &amp; fittings)</b>	52 in. (132 cm)
<b>Length Overall, w / Extended Screen</b>	57 in. (145 cm)
<b>Weight</b>	11 lbs. (5.0 kg)
<b>Max. Flow Rate</b>	7.3 gpm (27.6 lpm) - See Flow Rate Chart
<b>Pump Volume / Cycle</b>	0.23 - 0.32 gal (0.87 - 1.21L)
<b>Max. Depth</b>	220 ft. (67 m)
<b>Air Pressure Range</b>	5 - 100 psi (0.4 - 7.0 kg/cm <sup>2</sup> )
<b>Min. Actuation Level</b>	31 in. (79 cm)
<b>Air Usage</b>	0.33-1.45 scf / gal. (2.5-10.8 liters of air / fluid liter) - See Air Usage Chart
<b>Min. Liquid Density</b>	0.7 SpG (0.7 g/cm <sup>3</sup> )
<b>Standard Construction Materials</b>	
<b>Pump Body</b>	Fiberglass or Stainless Steel
<b>Pump Ends</b>	Stainless Steel, UHMWPE <sup>2</sup> , Brass
<b>Internal Components</b>	Stainless Steel, Viton, Acetal, Nylon
<b>Tube &amp; Hose Fittings</b>	Brass or Stainless Steel
<b>Fitting Type</b>	Barbs or Quick Connects
<b>Tube Options</b>	
<b>Tubing Material</b>	Nylon
<b>Sizes<sup>1</sup> - Liquid Discharge</b>	3/4 in. (19 mm) or 1 in. (25 mm) OD
<b>Pump Air Supply</b>	1/2 in. (13 mm) OD
<b>Air Exhaust</b>	5/8 in. (16 mm) OD

<sup>1</sup> Applies to QED supplied tubing; other tubing sources may not conform to QED fittings.

<sup>2</sup> UHMWPE - Ultra High Molecular Weight Polyethylene

### Application Limits

AP3 AutoPumps are designed to handle the application range described below. For applications outside this range, consider the AP4 and AP2 models.

Maximum Temperature: 120°F (49°C)

pH Range: 4-9

Some solvents and Fuels: gasoline, diesel fuel, BTEX, MTBE

AP3 AutoPumps are warranted for two (2) years: 100% materials and workmanship.

### Flow Rates<sup>1</sup>

**.75 inch (19 mm) O.D. Fluid Discharge Tubing**

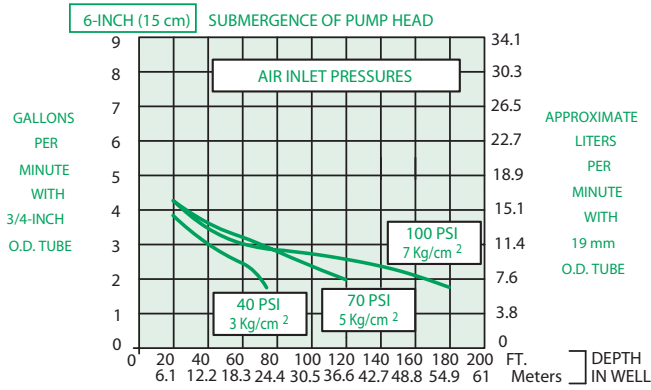

**1.00 inch (25 mm) O.D. Fluid Discharge Tubing**

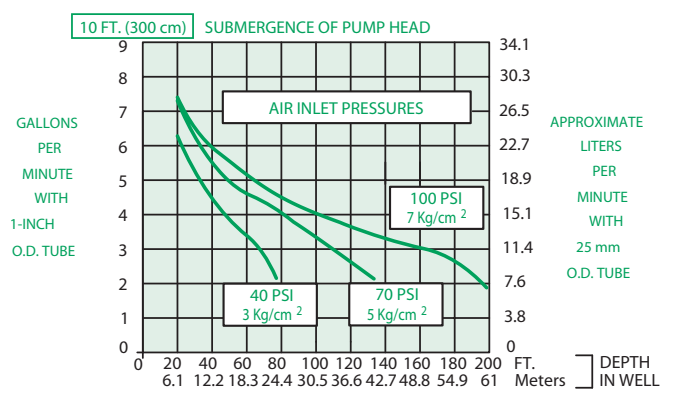
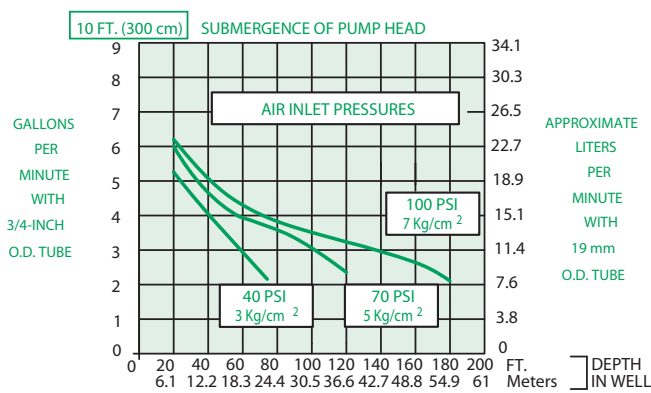
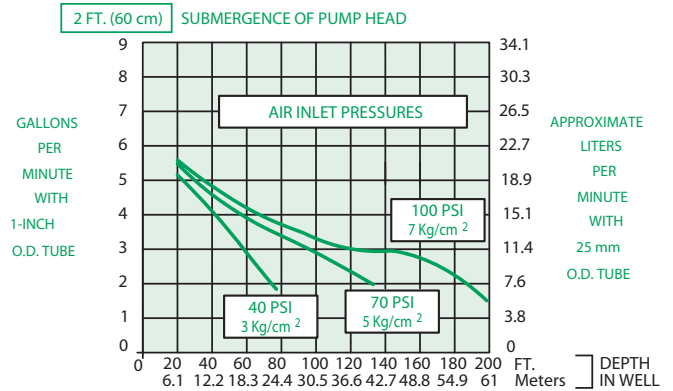
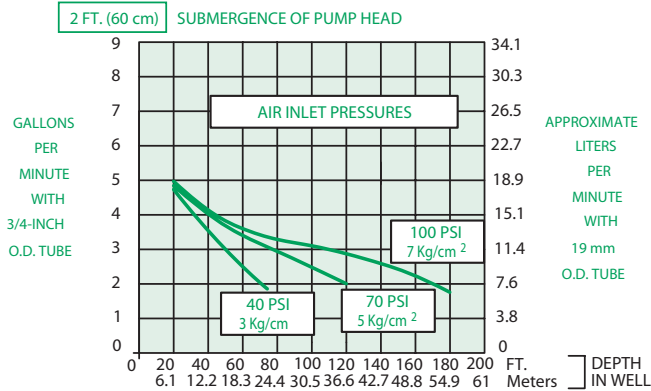
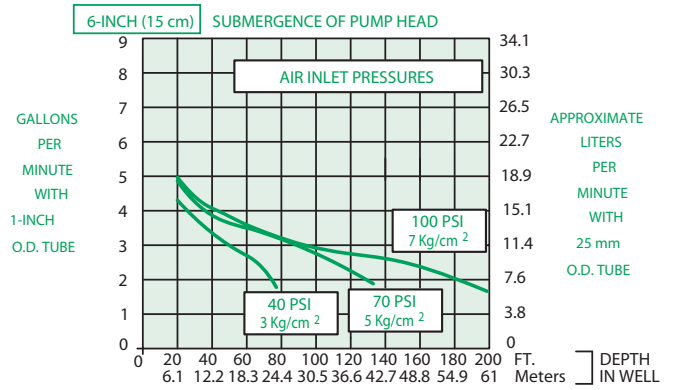

<sup>1</sup> FLOW RATES MAY VARY WITH SITE CONDITIONS. CALL QED FOR TECHNICAL ASSISTANCE.

### Air Consumption

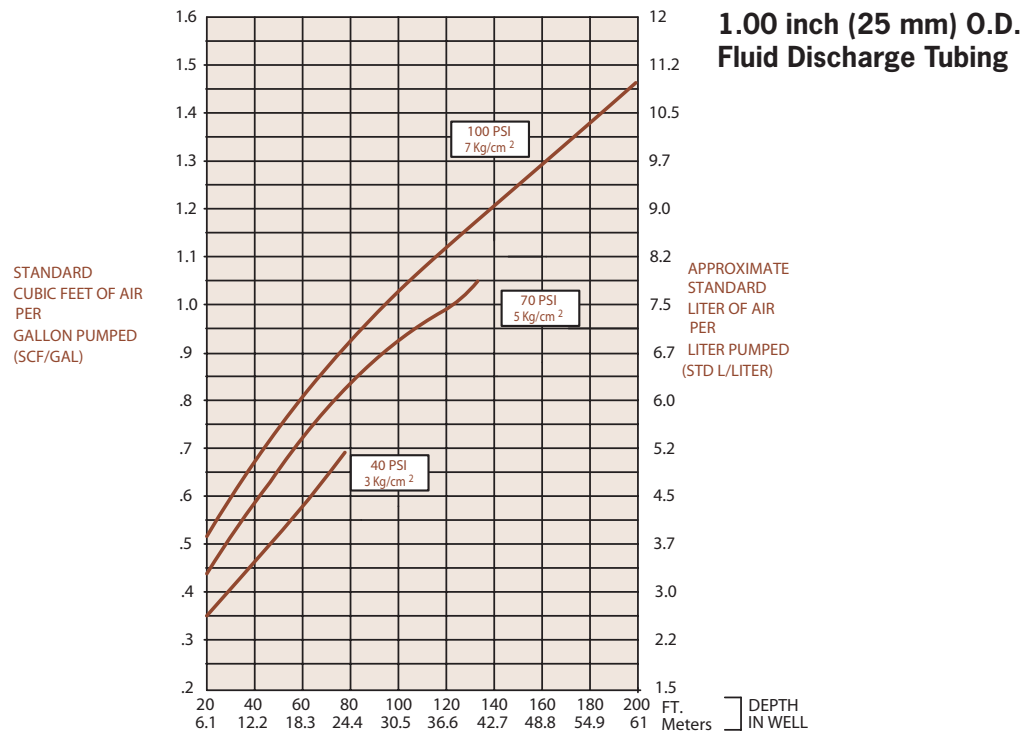
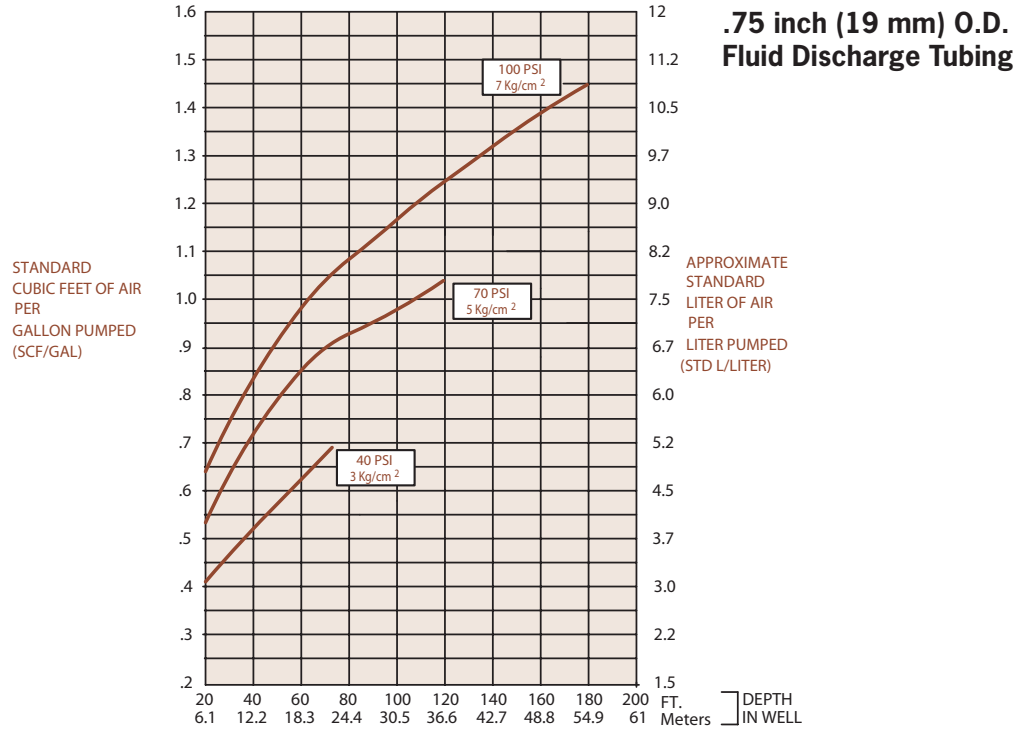

# AP3B

AutoPump®

## Bottom Inlet, Short

**Max. Flow** 6.0 gpm (22.7 lpm)

**O.D.** 2.63 in. (6.68 cm)

**Length** 42 in. (106.6 cm)



### Description

The AP3 Bottom Inlet Short AutoPump is designed for moderate-duty remediation pumping applications with well casings 3" (75 mm) diameter and larger. It is designed for wells having shorter water columns and/or the need to pump down to lower water levels, compared to full-length pumps. Complete system components such as tubing and hose sets, well caps, and flow counters are available for the AP3 Long Bottom Inlet AutoPump. Call QED for prompt, no-obligation assistance on your pumping project needs.

### The AutoPump Heritage

The AP3 Bottom Inlet Short AutoPump is part of the famous AutoPump family of original automatic air-powered pumps, developed in the mid 1980s specifically to handle unique pumping needs at remediation and landfill sites. Over the years they've proven their durability at thousands of sites worldwide. AutoPumps are designed to handle difficult pumping challenges that other pumps can't, such as solvents, suspended solids, corrosives, temperature extremes, viscous fluids and frequent start/stop cycles. Beyond just the pump, AutoPump systems offer the most complete range of tubing, hose, connectors, caps and accessories to help your installation go smoothly. This superior pumping heritage, application experience and support back up every AutoPump you put to work on your project.

### Advantages

1. Based on the original automatic air-powered well pump, proven worldwide over 25 years
2. Competitive flow rates and pumping capabilities
3. Patented, proven design for superior reliability and durability
4. Handles solids, some solvents, hydrocarbons and corrosive conditions beyond the limits of electric pumps
5. Two-year warranty

### Pump Dimensions

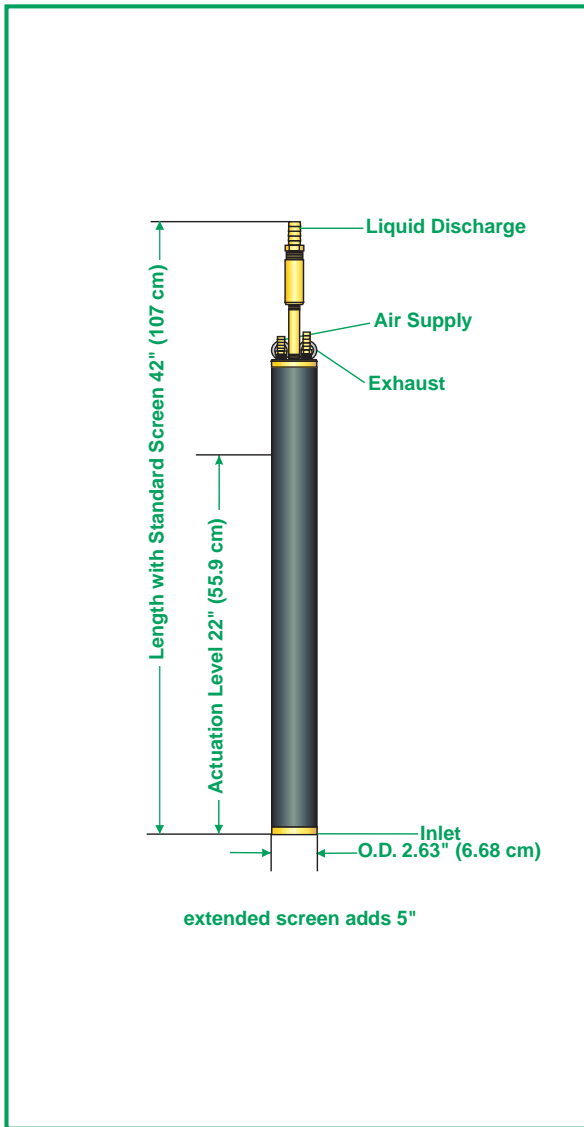

### Specifications & Operating Requirements

<b>Model</b>	<b>3" - Short AP3 Bottom Inlet</b>
<b>Liquid Inlet Location</b>	Bottom
<b>OD</b>	2.63 in. (6.68 cm)
<b>Length Overall (pump &amp; fittings)</b>	42 in. (107cm)
<b>Length Overall, w / Extended Screen</b>	47 in. (117cm)
<b>Weight</b>	10 lbs. (4.5 kg)
<b>Max. Flow Rate</b>	6.0 gpm (22.7 lpm) - See Flow Rate Chart
<b>Pump Volume / Cycle</b>	0.08 - 0.15 gal (.30 - 0.57L )
<b>Max. Depth</b>	175 ft. (53.3 m)
<b>Air Pressure Range</b>	5 -80 psi (0.4 - 5.6 kg/cm2)
<b>Min. Actuation Level</b>	22 in. (56 cm)
<b>Air Usage</b>	0.35 - 1.6 scf / gal. (2.6-12.0 liters of air / fluid liter) - See Air Usage Chart
<b>Min. Liquid Density</b>	0.7 SpG (0.7 g/cm3)
<b>Standard Construction Materials</b>	
<b>Pump Body</b>	Fiberglass or Stainless Steel
<b>Pump Ends</b>	Stainless Steel, UHMWPE*, Brass
<b>Internal Components</b>	Stainless Steel, Viton, Acetal, Nylon
<b>Tube &amp; Hose Fittings</b>	Brass or Stainless Steel
<b>Fitting Type</b>	Barbs or Quick Connects
<b>Tube Options</b>	
<b>Tubing Material</b>	Nylon
<b>Sizes<sup>1</sup> - Liquid Discharge</b>	3/4 in. (19 mm) or 1 in. (25 mm) OD
<b>Pump Air Supply</b>	1/2 in. (13 mm) OD
<b>Air Exhaust</b>	5/8 in. (16 mm) OD

<sup>1</sup> Applies to QED supplied tubing; other tubing sources may not conform to QED fittings.

<sup>2</sup> UHMWPE - Ultra High Molecular Weight Polyethylene

### Application Limits

AP3 AutoPumps are designed to handle the application ranges described below. For applications outside this range, consider the AP4 and AP2 models.

Maximum Temperature: 120°F (49°C)

pH Range: 4-9

Solvents and Fuels: gasoline, diesel fuel, BTEX, MTBE

AP3 AutoPumps are warranted for two (2) years: 100% materials and workmanship.

### Flow Rates<sup>1</sup>

**.75 inch (19 mm) O.D. Fluid Discharge Tubing**

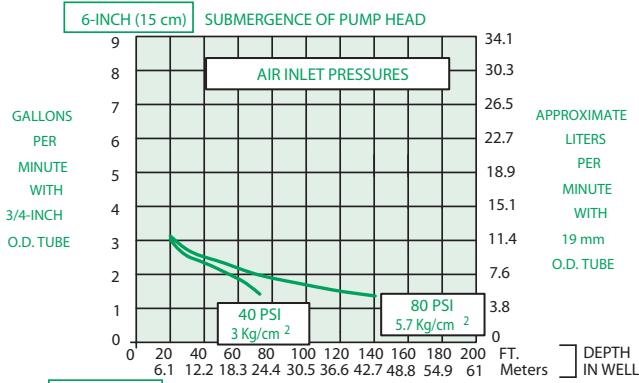

**1.00 inch (25 mm) O.D. Fluid Discharge Tubing**

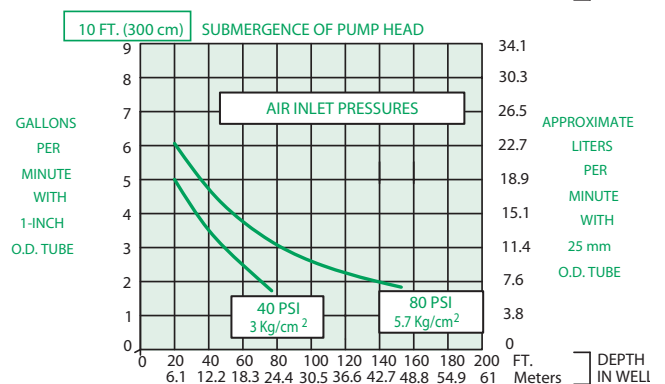
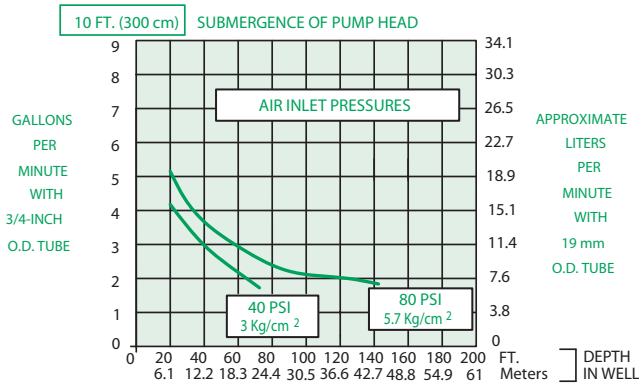
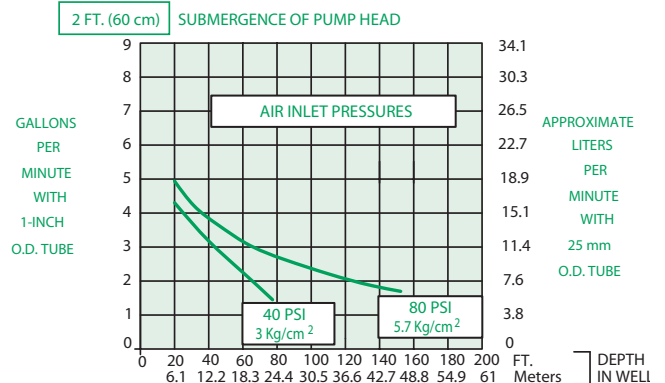
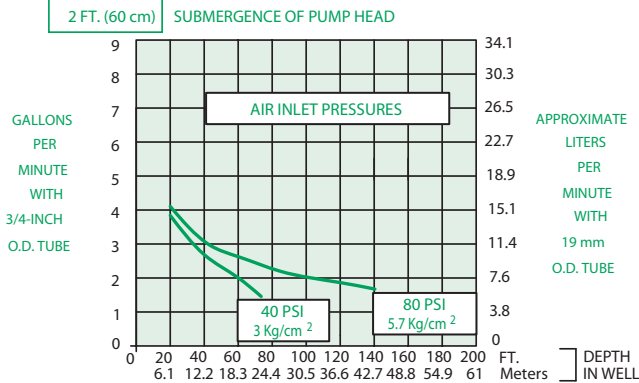
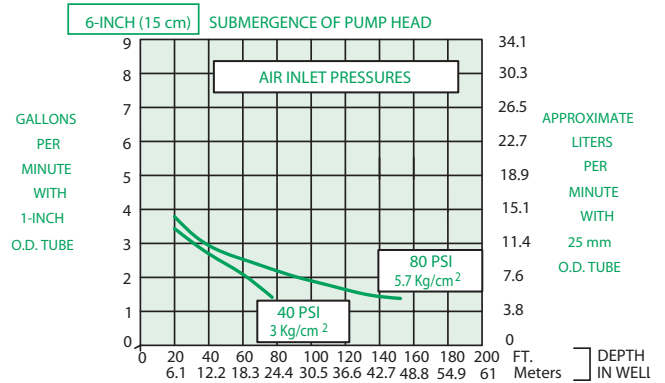

<sup>1</sup> FLOW RATES MAY VARY WITH SITE CONDITIONS. CALL QED FOR TECHNICAL ASSISTANCE.



### Air Consumption

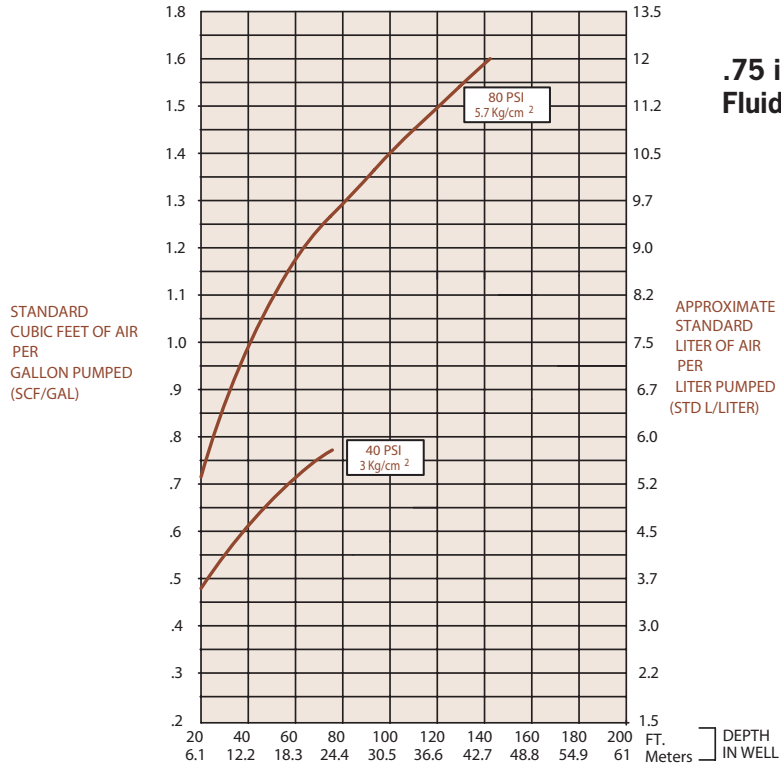

STANDARD CUBIC FEET OF AIR PER GALLON PUMPED (SCF/GAL)

APPROXIMATE STANDARD LITER OF AIR PER LITER PUMPED (STD L/LITER)

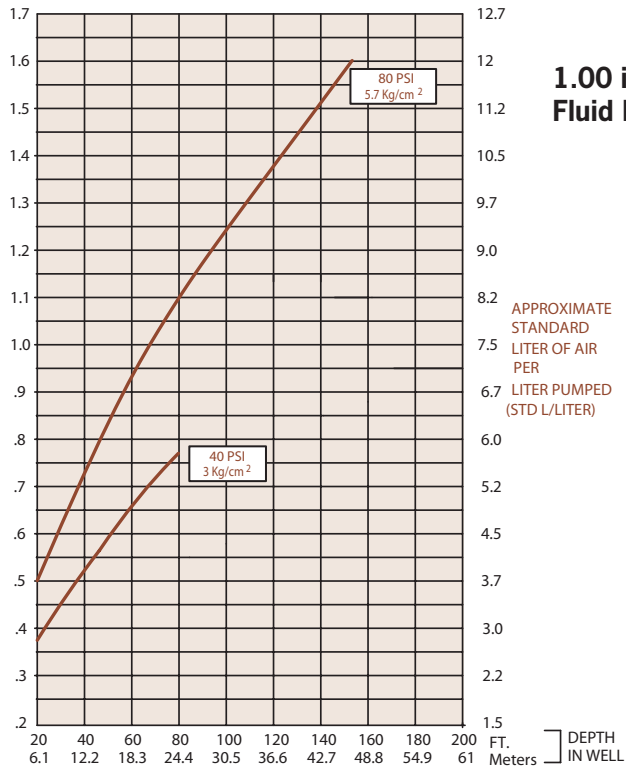

**1.00 inch (25 mm) O.D. Fluid Discharge Tubing**

# AP3T

AutoPump®

## Top Inlet, Long

**Max. Flow** 5.4 gpm (20 lpm)

**O.D.** 3.4 in. (8.64 cm)

**Optional O.D.** 2.6 in. (6.68 cm)

**Length** 57 in. (145 cm)

### Description

The AP3T Top Inlet Long AutoPump is designed for moderate-duty remediation pumping applications with well casings 3" (7.62 cm) diameter and larger using available 2.63" (6.68 cm) inlet. It is designed for applications requiring an elevated inlet, such as pumping total fluids from wells contaminated with LNAPLs. Call QED for prompt, no-obligation assistance on your pumping project needs.

### The AutoPump Heritage

The AP3T Top Inlet Long AutoPump is part of the famous AutoPump family of original automatic air-powered pumps, developed in the mid 1980s specifically to handle unique pumping needs at remediation and landfill sites. Over the years they've proven their durability at thousands of sites worldwide. AutoPumps are designed to handle difficult pumping challenges that other pumps can't, such as solvents, suspended solids, corrosives, temperature extremes, viscous fluids and frequent start/stop cycles. Beyond just the pump, AutoPump systems offer the most complete range of tubing, hose, connectors, caps and accessories to help your installation go smoothly. This superior pumping heritage, application experience and support back up every AutoPump you put to work on your project.

### Advantages

1. Based on the original automatic air-powered well pump, proven worldwide over 25 years
2. Competitive flow rates and pumping capabilities
3. Patented, proven design for superior reliability and durability
4. Handles solids, some solvents, hydrocarbons and corrosive conditions beyond the limits of electric pumps
5. Two-year warranty





### Pump Dimensions

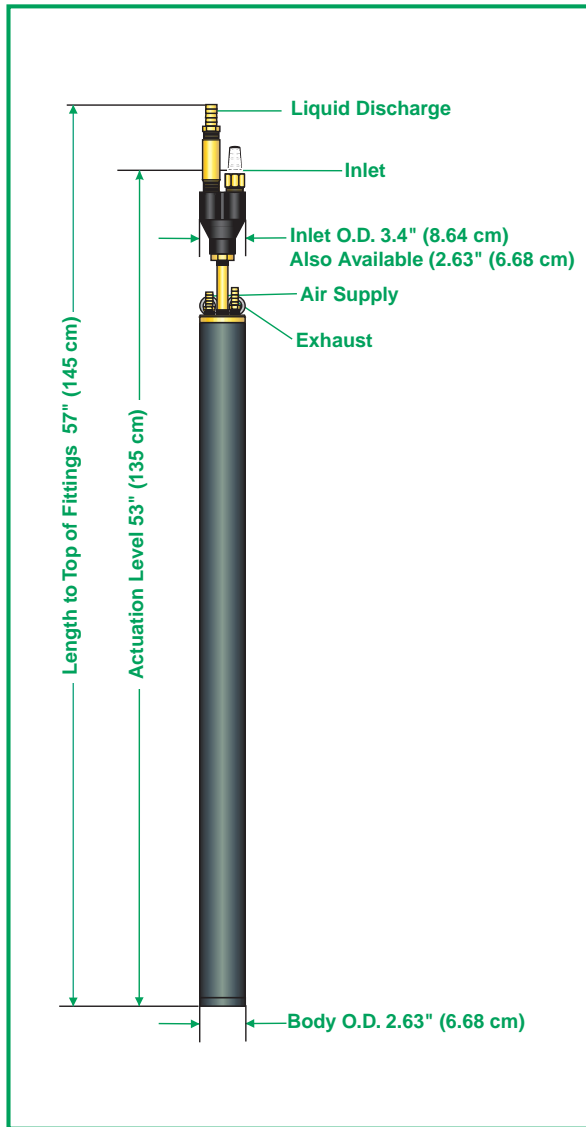

### Specifications & Operating Requirements

<b>Model</b>	<b>3" - Long AP3 Top Inlet</b>
<b>Liquid Inlet Location</b>	Top
<b>OD</b>	3.4 in. (8.64 cm) (2.63 in. Available)
<b>Length Overall (pump &amp; fittings)</b>	57 in. (145 cm)
<b>Weight</b>	11.5 lbs. (5.3 kg)
<b>Max. Flow Rate</b>	5.4 gpm (20.4 lpm) - See Flow Rate Chart
<b>Pump Volume / Cycle</b>	0.23 - 0.32 gal (0.87 - 1.21 L)
<b>Max. Depth</b>	220 ft. (67 m)
<b>Air Pressure Range</b>	5 - 100 psi (0.4 - 7.0 kg/cm <sup>2</sup> )
<b>Min. Actuation Level</b>	53 in. (135 cm)
<b>Air Usage</b>	0.41 - 1.59 scf / gal. (3.0 - 11.9 liters of air / fluid liter) - See Air Usage Chart
<b>Min. Liquid Density</b>	0.7 SpG (0.7 g/cm <sup>3</sup> )
<b>Standard Construction Materials</b>	
<b>Pump Body</b>	Fiberglass or Stainless Steel
<b>Pump Ends</b>	Stainless Steel, Acetal, Brass
<b>Internal Components</b>	Stainless Steel, Viton, Acetal, Nylon
<b>Tube &amp; Hose Fittings</b>	Brass or Stainless Steel
<b>Fitting Type</b>	Barbs or Quick Connects
<b>Tube Options</b>	
<b>Tubing Material</b>	Nylon
<b>Sizes<sup>1</sup> - Liquid Discharge</b>	3/4 in. (19 mm) or 1 in. (25 mm) OD
<b>Pump Air Supply</b>	1/2 in. (13 mm) OD
<b>Air Exhaust</b>	5/8 in. (16 mm) OD

<sup>1</sup> Applies to QED supplied tubing; other tubing sources may not conform to QED fittings.

### Application Limits

AP3 AutoPumps are designed to handle the application ranges described below. For applications outside this range, consider the AP4 and AP2 models.

Maximum Temperature: 120°F (49°C)

pH Range: 4-9

Solvents and Fuels: gasoline, diesel fuel, BTEX, MTBE

AP3 AutoPumps are warranted for two (2) years: 100% materials and workmanship.

### Flow Rates<sup>1</sup>

**.75 inch (19 mm) O.D. Fluid Discharge Tubing**

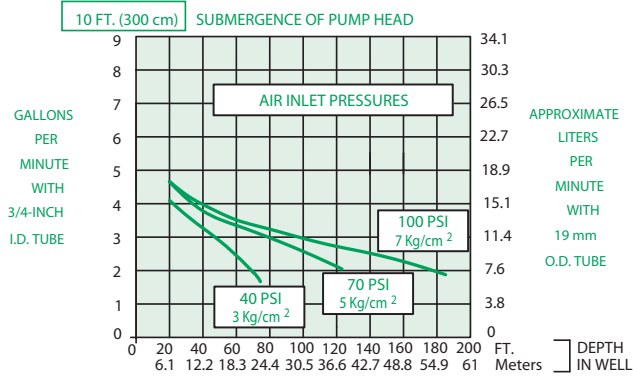
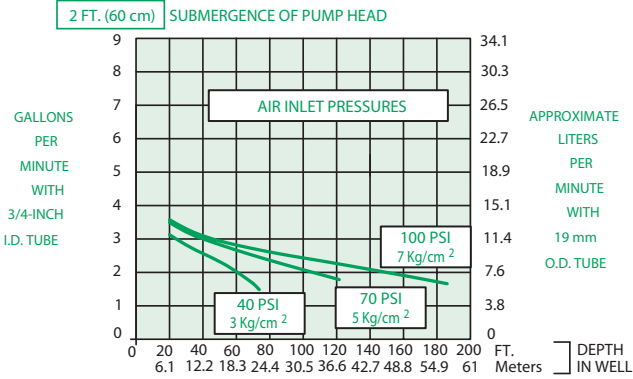
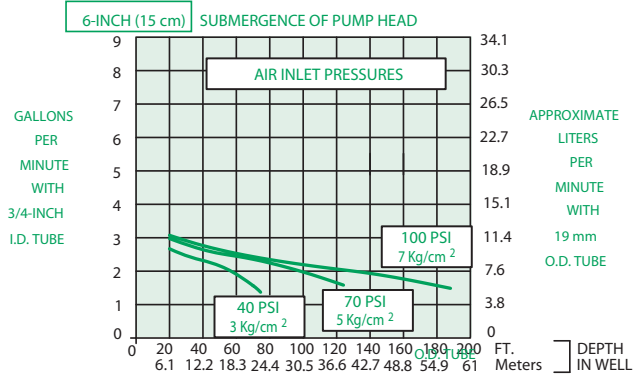

**1.00 inch (25 mm) O.D. Fluid Discharge Tubing**

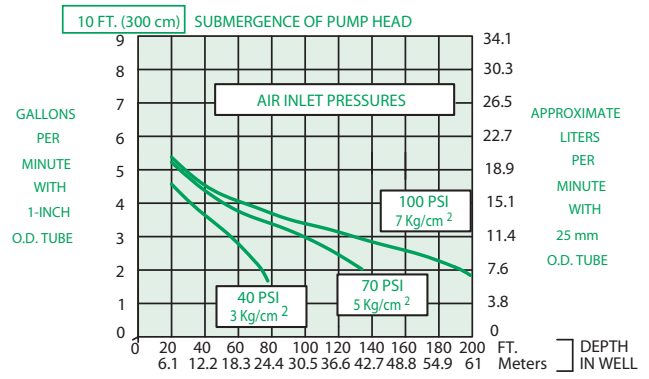
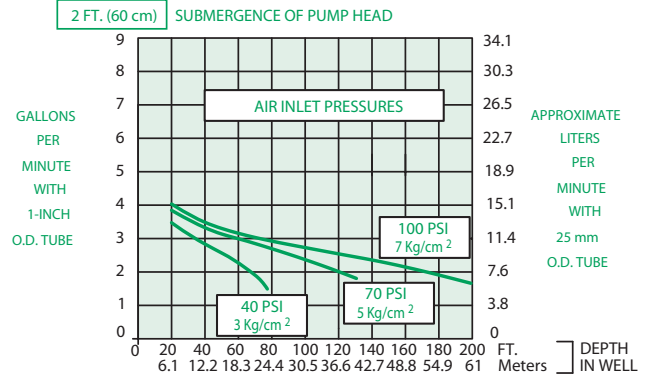
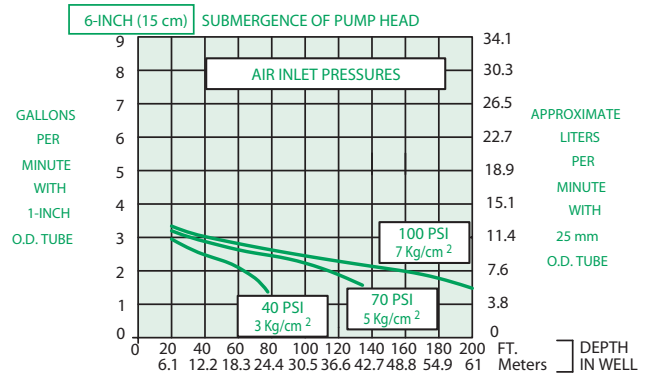

<sup>1</sup> FLOW RATES MAY VARY WITH SITE CONDITIONS. CALL QED FOR TECHNICAL ASSISTANCE.

### Air Consumption



STANDARD  
CUBIC FEET OF AIR  
PER  
GALLON PUMPED  
(SCF/GAL)

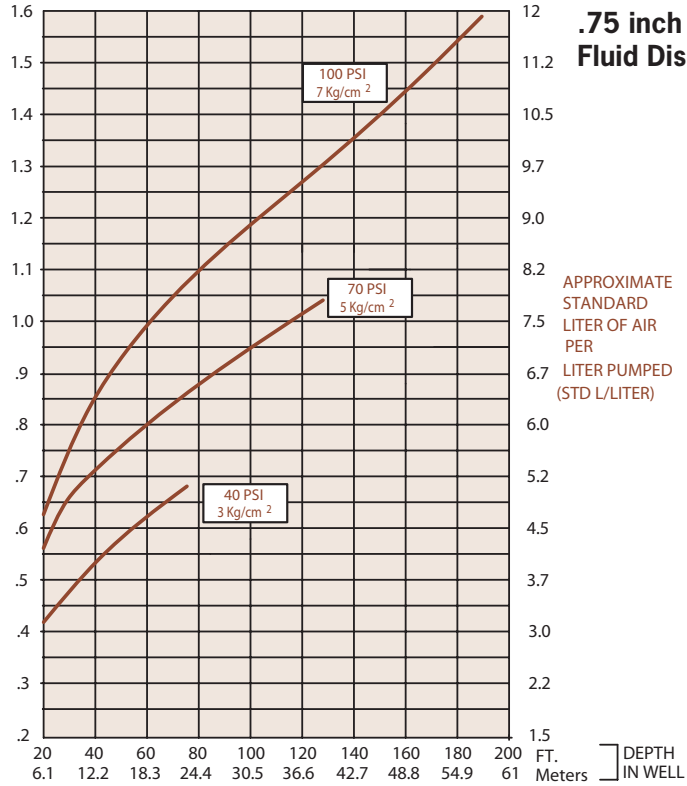

**.75 inch (19 mm) O.D.  
Fluid Discharge Tubing**

APPROXIMATE  
STANDARD  
LITER OF AIR  
PER  
LITER PUMPED  
(STD L/LITER)

STANDARD  
CUBIC FEET OF AIR  
PER  
GALLON PUMPED  
(SCF/GAL)

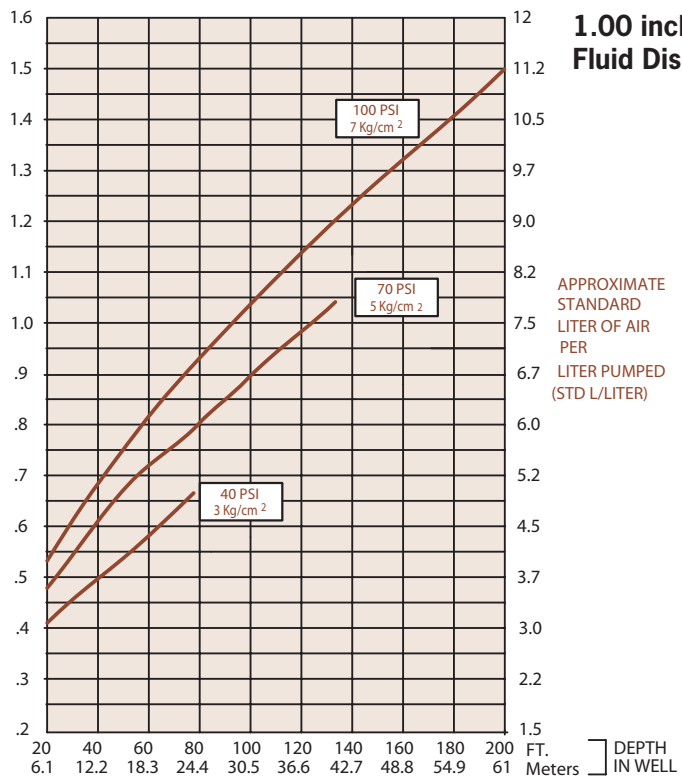

**1.00 inch (25 mm) O.D.  
Fluid Discharge Tubing**

APPROXIMATE  
STANDARD  
LITER OF AIR  
PER  
LITER PUMPED  
(STD L/LITER)

# AP3T

AutoPump®

## Top Inlet, Short

**Max. Flow** 4.8 gpm (18.1 lpm)

**O.D.** 3.4 in. (8.64 cm)

**Length** 47 in. (119 cm)

### Description

The AP3T Top Inlet Short AutoPump is designed for moderate-duty remediation pumping applications with well casings 3" (7.62 cm) diameter and larger using available 2.63" (6.68 cm) inlet. It is designed for applications requiring an elevated inlet, such as pumping total fluids from wells contaminated with LNAPLs. Call QED for prompt, no-obligation assistance on your pumping project needs.

### The AutoPump Heritage

The AP3T Top Inlet Short AutoPump is part of the famous AutoPump family of original automatic air-powered pumps, developed in the mid 1980s specifically to handle unique pumping needs at remediation and landfill sites. Over the years they've proven their durability at thousands of sites worldwide. AutoPumps are designed to handle difficult pumping challenges that other pumps can't, such as solvents, suspended solids, corrosives, temperature extremes, viscous fluids and frequent start/stop cycles. Beyond just the pump, AutoPump systems offer the most complete range of tubing, hose, connectors, caps and accessories to help your installation go smoothly. This superior pumping heritage, application experience and support back up every AutoPump you put to work on your project.



### Advantages

1. Based on the original automatic air-powered well pump, proven worldwide over 25 years
2. Competitive flow rates and pumping capabilities
3. Patented, proven design for superior reliability and durability
4. Handles solids, some solvents, hydrocarbons and corrosive conditions beyond the limits of electric pumps
5. Two-year warranty

### Pump Dimensions

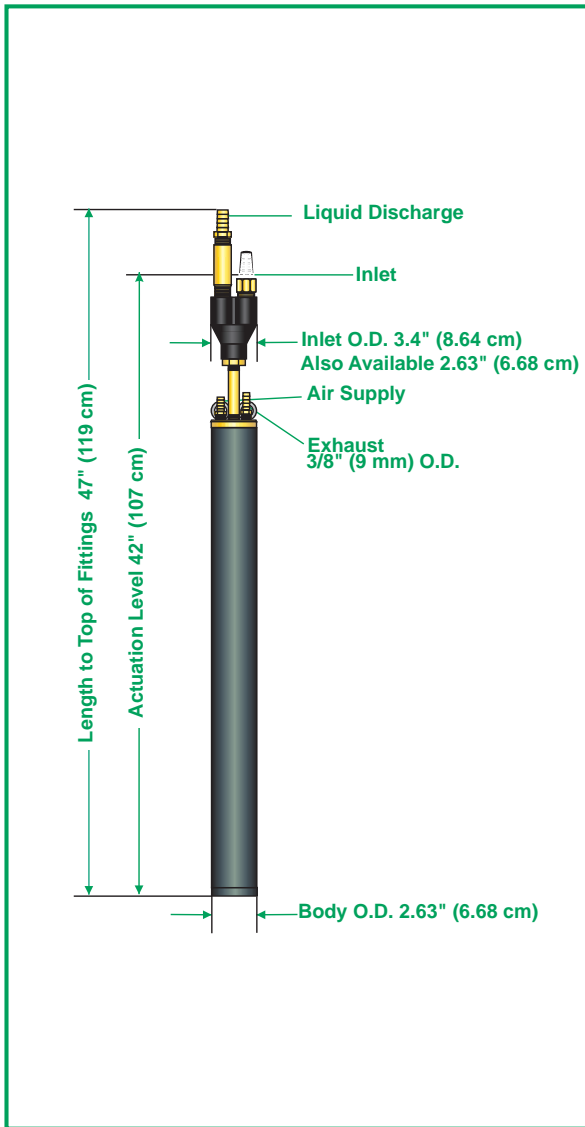

### Specifications & Operating Requirements

<b>Model</b>	<b>3" - Short AP3 Top Inlet</b>
<b>Liquid Inlet Location</b>	Top
<b>OD</b>	3.4 in. (8.64 cm) (2.63 in. Available)
<b>Length Overall (pump &amp; fittings)</b>	47 in. (119 cm)
<b>Weight</b>	10 lbs. (4.5 kg)
<b>Max. Flow Rate</b>	4.8 gpm (18.1 lpm) - See Flow Rate Chart
<b>Pump Volume / Cycle</b>	0.08 - 0.15 gal (.30 - 0.57L)
<b>Max. Depth</b>	175 ft. (53.3 m)
<b>Air Pressure Range</b>	5 - 80 psi (0.4 - 5.6 kg/cm <sup>2</sup> )
<b>Min. Actuation Level</b>	42 in. (107 cm)
<b>Air Usage</b>	0.43 - 1.6 scf / gal. (3.2 - 12.0 liters of air / fluid liter) - See Air Usage Chart
<b>Min. Liquid Density</b>	0.7 SpG (0.7 g/cm <sup>3</sup> )
<b>Standard Construction Materials</b>	
<b>Pump Body</b>	Fiberglass or Stainless Steel
<b>Pump Ends</b>	Stainless Steel, Acetal, HDPE, Brass
<b>Internal Components</b>	Stainless Steel, Viton, Acetal, Nylon
<b>Tube &amp; Hose Fittings</b>	Brass or Stainless Steel
<b>Fitting Type</b>	Barbs or Quick Connects
<b>Tube Options</b>	
<b>Tubing Material</b>	Nylon
<b>Sizes<sup>1</sup> - Liquid Discharge</b>	3/4 in. (19 mm) or 1 in. (25 mm) OD
<b>Pump Air Supply</b>	1/2 in. (13 mm) OD
<b>Air Exhaust</b>	5/8 in. (16 mm) OD

<sup>1</sup> Applies to QED supplied tubing; other tubing sources may not conform to QED fittings.

### Application Limits

AP3 AutoPumps are designed to handle the application ranges described below. For applications outside this range, consider the AP4 and AP2 models.

Maximum Temperature: 120°F (49°C)

pH Range: 4-9

Solvents and Fuels: gasoline, diesel fuel, BTEX, MTBE

AP3 AutoPumps are warranted for two (2) years: 100% materials and workmanship.

### Flow Rates<sup>1</sup>

**.75 inch (19 mm) O.D. Fluid Discharge Tubing**

**1.00 inch (25 mm) O.D. Fluid Discharge Tubing**

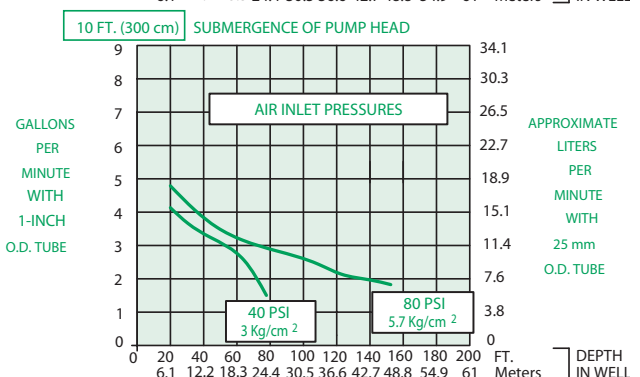
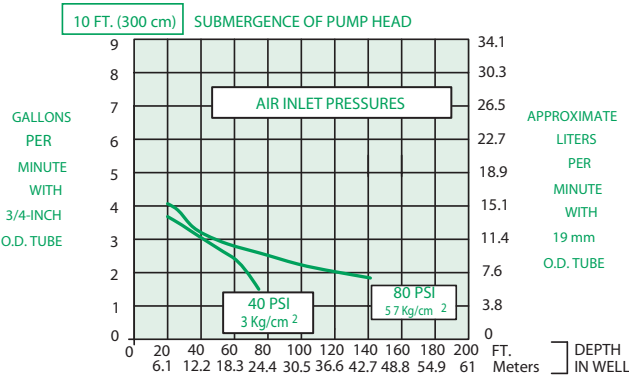
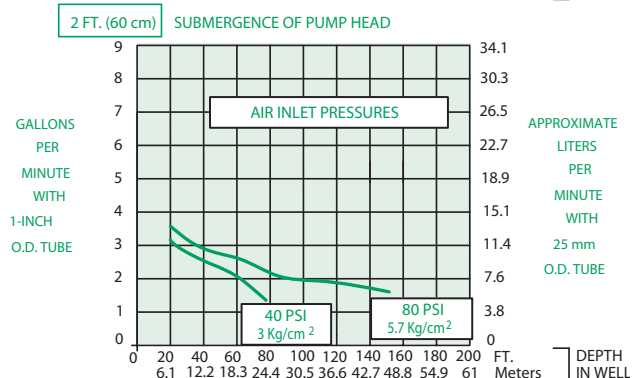
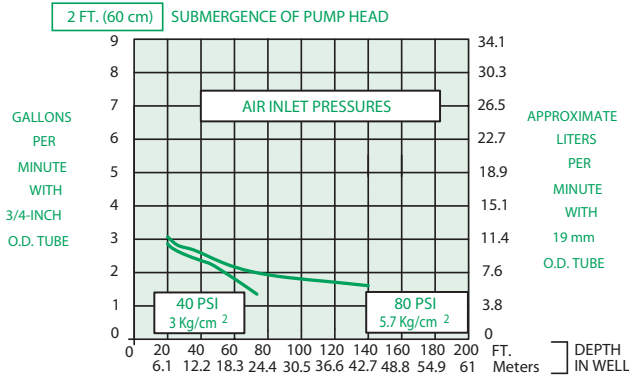
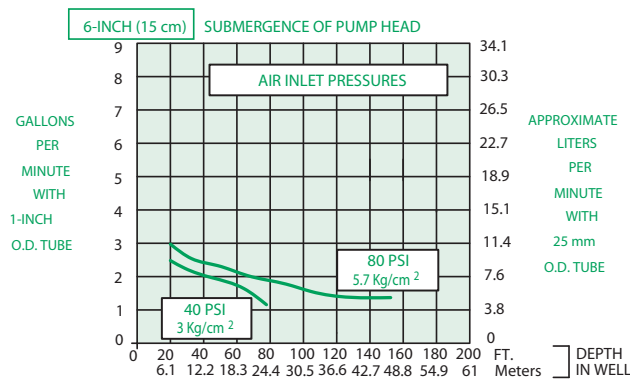
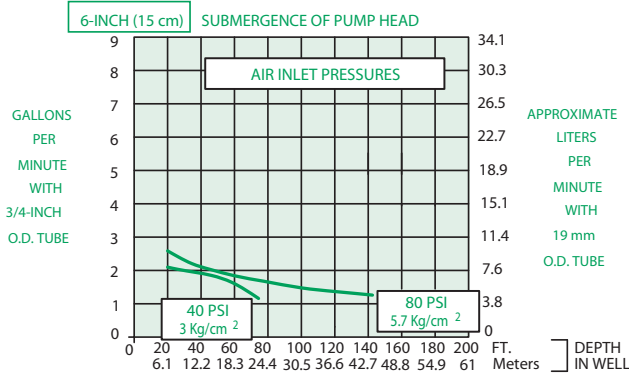

<sup>1</sup> FLOW RATES MAY VARY WITH SITE CONDITIONS. CALL QED FOR TECHNICAL ASSISTANCE.

### Air Consumption



STANDARD  
CUBIC FEET OF AIR  
PER  
GALLON PUMPED  
(SCF/GAL)

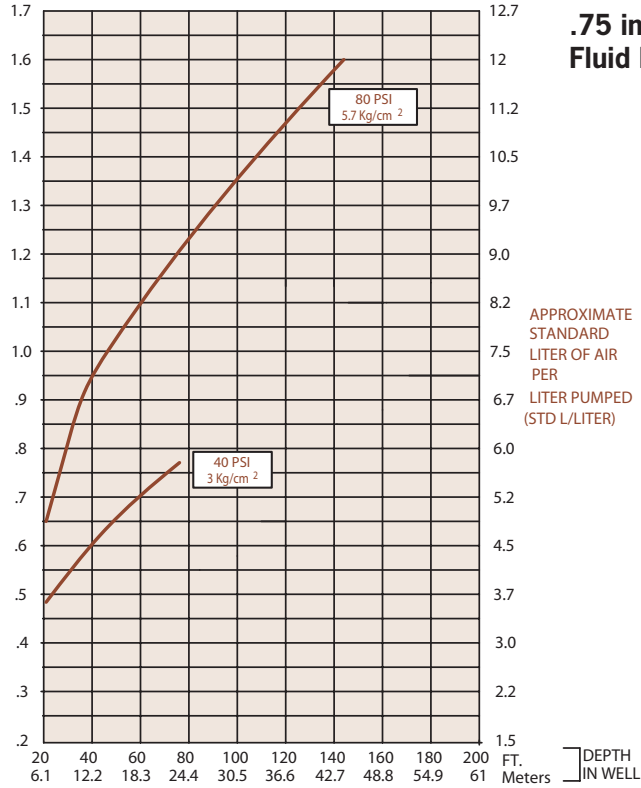

**.75 inch (19 mm) O.D.  
Fluid Discharge Tubing**

STANDARD  
CUBIC FEET OF AIR  
PER  
GALLON PUMPED  
(SCF/GAL)

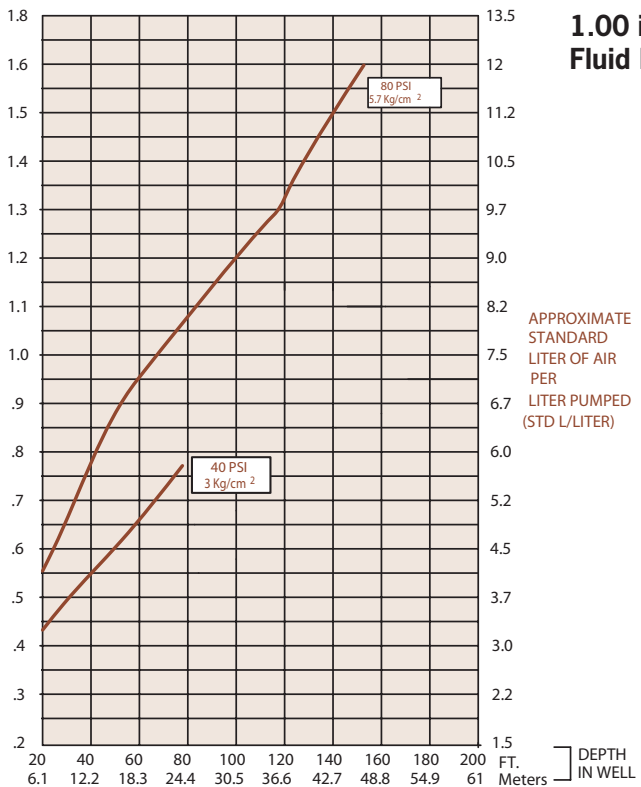

**1.00 inch (25 mm) O.D.  
Fluid Discharge Tubing**

# AP2B

# AutoPump®

## Bottom Inlet, Long

**Max. Flow** 2.3 gpm (8.8 lpm)

**O.D.** 1.75 in. (4.45 cm)

**Length** 55 in. (139 cm)



### Description

The AP2 Bottom Inlet Long AutoPump provides maximum capabilities and flow in a bottom inlet pump for 2" (50 mm) diameter wells. It is offered in optional versions to handle even severe remediation and landfill pumping applications, and delivers flow rates up to 2.3 gpm (8.8 lpm). The AP2 Long Bottom Inlet AutoPump is complemented by the most comprehensive selection of accessories to provide a complete system to meet site-specific requirements. Call QED for prompt, no-obligation assistance on your pumping project needs.

### The AutoPump Heritage

The AP2 Bottom Inlet Long AutoPump is part of the famous AutoPump family of original automatic air-powered pumps, developed in the mid 1980s specifically to handle unique pumping needs at remediation and landfill sites. Over the years they've proven their durability at thousands of sites worldwide. AutoPumps are designed to handle difficult pumping challenges that other pumps can't, such as solvents, suspended solids, corrosives, temperature extremes, viscous fluids and frequent start/stop cycles. Beyond just the pump, AutoPump systems offer the most complete range of tubing, hose, connectors, caps and accessories to help your installation go smoothly. This superior pumping heritage, application experience and support back up every AutoPump you put to work on your project.

### Advantages

1. **The original 2" automatic air-powered well pump, proven worldwide over 15 years**
2. **The industry leader in reliability, durability, flow rate and depth capability in an automatic pump for 2-inch wells**
3. **Handles solids, hydrocarbons, solvents, corrosive conditions, viscous fluids and landfill liquids**
4. **One-year warranty**



### Pump Dimensions

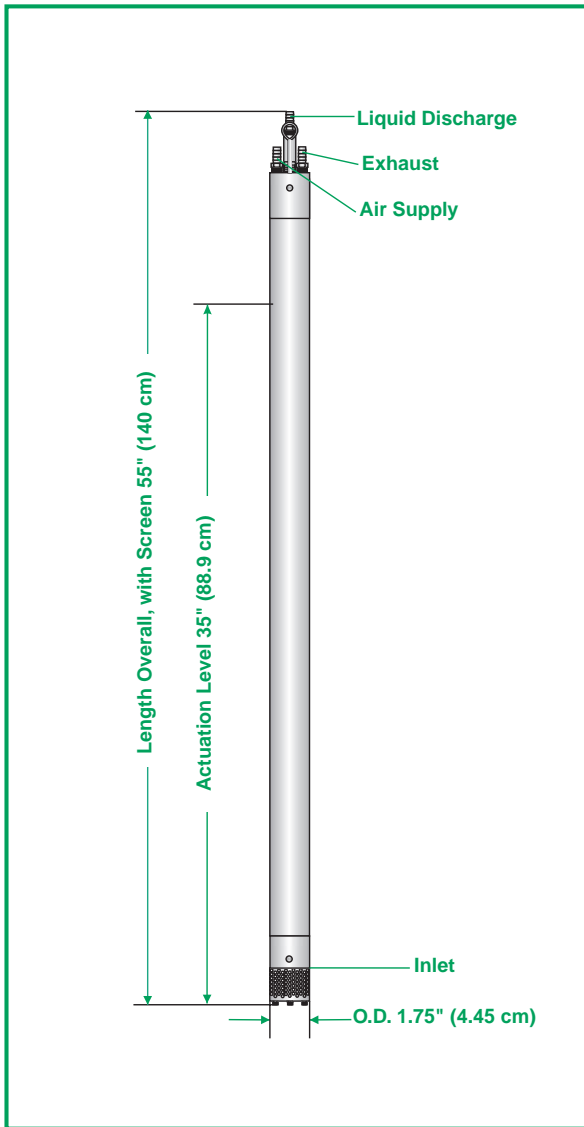

### Specifications & Operating Requirements

<b>Model</b>	<b>2" - Long AP2 Bottom Inlet</b>
<b>Liquid Inlet Location</b>	Bottom
<b>OD</b>	1.75 in. (4.45 cm)
<b>Length Overall (pump &amp; fittings)</b>	55 in. (139 cm)
<b>Length Overall, w / Extended Screen</b>	57 in. (144 cm)
<b>Weight</b>	7.8 lb (3.6 Kg)
<b>Max. Flow Rate</b>	2.3 gpm (8.8 lpm) - See Flow Rate Chart
<b>Pump Volume / Cycle</b>	0.14 - 0.17gal (0.53 - 0.64 L)
<b>Max. Depth</b>	300 ft (91.4 m)
<b>Air Pressure Range</b>	5 - 130 psi (0.4 - 9.2 kg/cm <sup>2</sup> )
<b>Min. Actuation Level</b>	35 in. (88.9 cm)
<b>Air Usage</b>	0.38 - 1.45 scf / gal. (2.8 - 10.8 liters of air / fluid liter) See Air Usage Chart
<b>Min. Liquid Density</b>	0.7 SpG (0.7 g/cm <sup>3</sup> )
<b>Standard Construction Materials<sup>1</sup></b>	
<b>Pump Body</b>	Stainless Steel
<b>Pump Ends</b>	Stainless Steel
<b>Internal Components</b>	Stainless Steel, Viton, PVDF <sup>3</sup>
<b>Tube &amp; Hose Fittings</b>	Brass or Stainless Steel
<b>Fitting Type</b>	Barbs or Quick Connects
<b>Tube &amp; Hose Options</b>	
<b>Tubing Material</b>	Nylon
<b>Sizes<sup>2</sup> - Liquid Discharge</b>	5/8 in. (16 mm) OD
<b>Pump Air Supply</b>	3/8 in. (9.5 mm) OD
<b>Air Exhaust</b>	1/2 in. (13 mm) OD
<b>Hose Material</b>	Nitrile
<b>Sizes - Liquid Discharge</b>	1/2 in. (13 mm) ID
<b>Pump Air Supply</b>	1/4 in. (6.4 mm) ID
<b>Air Exhaust</b>	3/8 in. (9.5 mm) ID

<sup>1</sup> Material upgrades available  
<sup>2</sup> Applies to QED supplied tubing;  
 other tubing sources may not  
 conform to QED fittings.

<sup>3</sup> PVDF - Polyvinylidene Fluoride

### Application Limits (base model)

Base model AP2 AutoPumps are designed to handle the application ranges described below. For applications outside this range, consult QED about AP2 upgrades.

Maximum Temperature: 150°F (65°C)

pH Range: 4-9

Solvents and Fuels: diesel, gasoline, JP1-JP6,  
 #2 heating oils, BTEX, MTBE, landfill liquids

AP2 AutoPumps are warranted for one (1) year:  
 100% materials and workmanship.

### Flow Rates<sup>1</sup>

**1/2 inch (13 mm)  
Inside Diameter Discharge Hose**  
(Equivalent to 5/8-Inch O.D. Tubing)

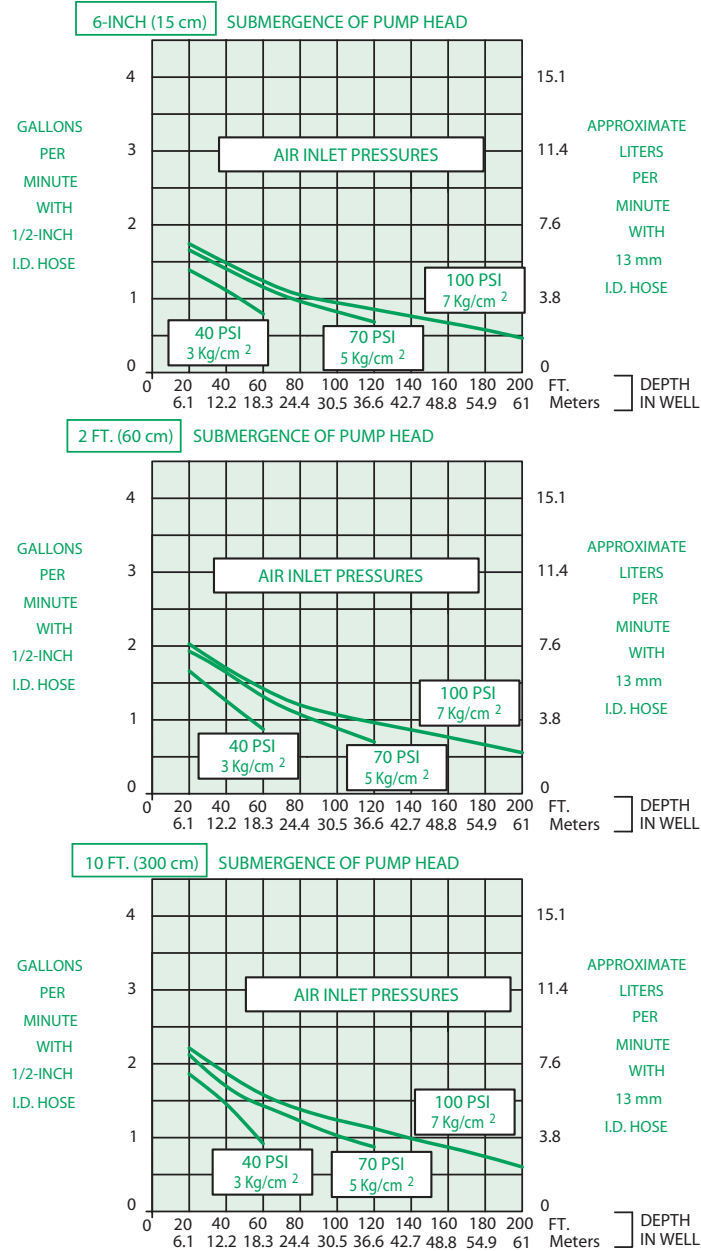

<sup>1</sup> FLOW RATES MAY VARY WITH SITE CONDITIONS. CALL QED FOR TECHNICAL ASSISTANCE.

### Air Consumption



STANDARD  
CUBIC FEET OF AIR  
PER  
GALLON PUMPED  
(SCF/GAL)

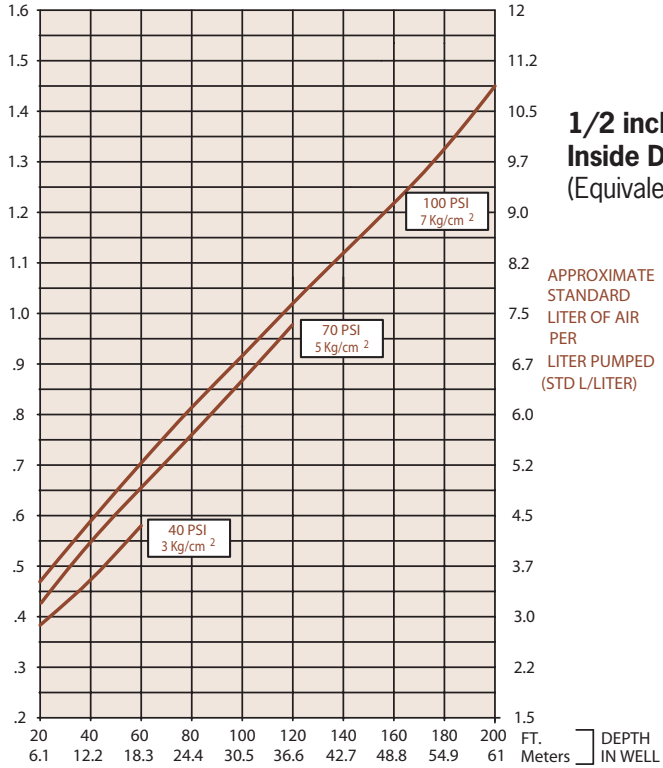

**1/2 inch (13 mm)  
Inside Diameter Discharge Hose**  
(Equivalent to 5/8-Inch O.D. Tubing)

APPROXIMATE  
STANDARD  
LITER OF AIR  
PER  
LITER PUMPED  
(STD L/LITER)

DEPTH  
IN WELL

# AP2B

# AutoPump®

## Bottom Inlet, Short

**Max. Flow** 2.0 gpm (7.6 lpm)

**O.D.** 1.75 in. (4.45 cm)

**Length** 33 in. (85 cm)



### Description

The AP2 Bottom Inlet Short AutoPump provides maximum capabilities and flow in a bottom inlet pump for 2" (50 mm) diameter wells. It is offered in optional versions to handle even severe remediation and landfill pumping applications, and delivers flow rates up to 2.0 gpm (7.6 lpm). The AP2 Short Bottom Inlet AutoPump is complemented by the most comprehensive selection of accessories to provide a complete system to meet site-specific requirements. Call QED for prompt, no-obligation assistance on your pumping project needs.

### The AutoPump Heritage

The AP2 Bottom Inlet Short AutoPump is part of the famous AutoPump family of original automatic air-powered pumps, developed in the mid 1980s specifically to handle unique pumping needs at remediation and landfill sites. Over the years they've proven their durability at thousands of sites worldwide. AutoPumps are designed to handle difficult pumping challenges that other pumps can't, such as solvents, suspended solids, corrosives, temperature extremes, viscous fluids and frequent start/stop cycles. Beyond just the pump, AutoPump systems offer the most complete range of tubing, hose, connectors, caps and accessories to help your installation go smoothly. This superior pumping heritage, application experience and support back up every AutoPump you put to work on your project.

### Advantages

1. The original 2" automatic air-powered well pump, proven worldwide over 15 years
2. The industry leader in reliability, durability, flow rate and depth capability in an automatic pump for 2-inch wells
3. Handles solids, hydrocarbons, solvents, corrosive conditions, viscous fluids and landfill liquids
4. One-year warranty

### Pump Dimensions

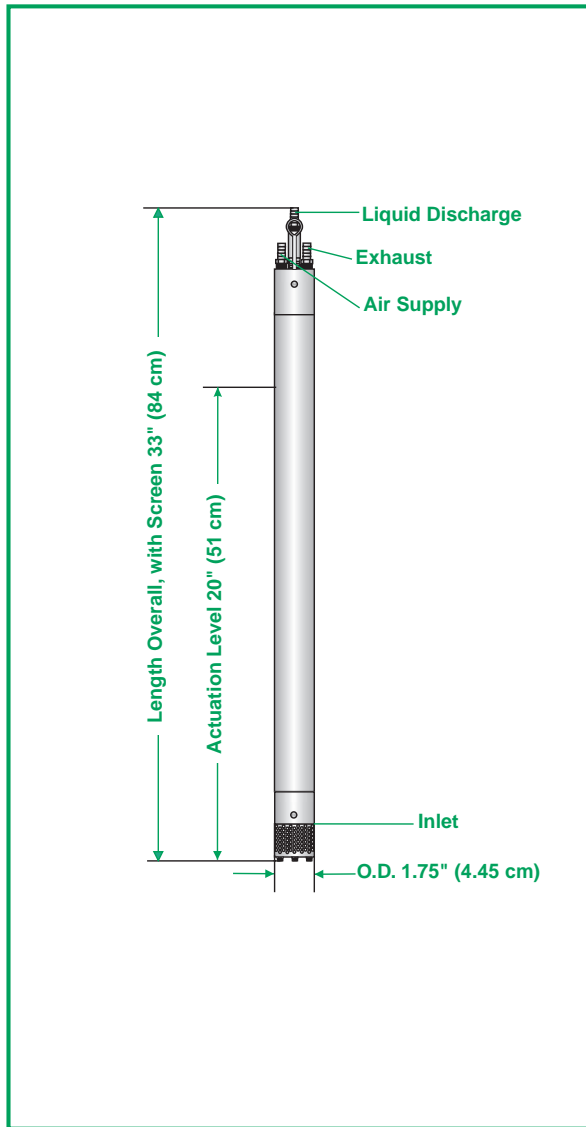

### Specifications & Operating Requirements

<b>Model</b>	<b>2" - Short AP2 Bottom Inlet</b>
<b>Liquid Inlet Location</b>	Bottom
<b>OD</b>	1.75 in. (4.45 cm)
<b>Length Overall (pump &amp; fittings)</b>	33 in (85 cm)
<b>Length Overall, w / Extended Screen</b>	35. in (89cm)
<b>Weight</b>	5.4 lb (3.6 Kg)
<b>Max. Flow Rate</b>	2.0 gpm (7.6 lpm)
<b>Pump Volume / Cycle</b>	0.05 - 0.08 gal (0.19 - 0.30 L)
<b>Max. Depth</b>	300 ft (91.4 m)
<b>Air Pressure Range</b>	5 - 130 psi (0.4 - 9.2 kg/cm <sup>2</sup> )
<b>Min. Actuation Level</b>	20 in. (51 cm)
<b>Air Usage</b>	.39-2.58 scf/gal (2.9-19.3 liters of air/fluid liter see Air Usage Chart)
<b>Min. Liquid Density</b>	0.7 SpG (0.7 g/cm <sup>3</sup> )
<b>Standard Construction Materials<sup>1</sup></b>	
<b>Pump Body</b>	Stainless Steel
<b>Pump Ends</b>	Stainless Steel
<b>Internal Components</b>	Stainless Steel, Viton, PVDF <sup>3</sup>
<b>Tube &amp; Hose Fittings</b>	Brass or Stainless Steel
<b>Fitting Type</b>	Barbs or Quick Connects
<b>Tube &amp; Hose Options</b>	
<b>Tubing Material</b>	Nylon
<b>Sizes<sup>2</sup> - Liquid Discharge</b>	5/8 in. (16 mm) OD
<b>Pump Air Supply</b>	3/8 in. (9.5 mm) OD
<b>Air Exhaust</b>	1/2 in. (13 mm) OD
<b>Hose Material</b>	Nitrile
<b>Sizes - Liquid Discharge</b>	1/2 in. (13 mm) ID
<b>Pump Air Supply</b>	1/4 in (6.4 mm) ID
<b>Air Exhaust</b>	3/8 in. (9.5 mm) ID

<sup>1</sup> Material upgrades available  
<sup>2</sup> Applies to QED supplied tubing;  
 other tubing sources may not  
 conform to QED fittings.

<sup>3</sup> PVDF - Polyvinylidene Fluoride

### Application Limits (base model)

Base model AP2 AutoPumps are designed to handle the application ranges described below. For applications outside this range, consult QED about AP2 upgrades.

Maximum Temperature: 150°F (65°C)

pH Range: 4-9

Solvents and Fuels: diesel, gasoline, JP1-JP6,  
 #2 heating oils, BTEX, MTBE, landfill liquids

AP2 AutoPumps are warranted for one (1) year:  
 100% materials and workmanship.

### Flow Rates<sup>1</sup>

**1/2 inch (13 mm)  
Inside Diameter Discharge Hose**  
(Equivalent to 5/8-Inch O.D. Tubing)

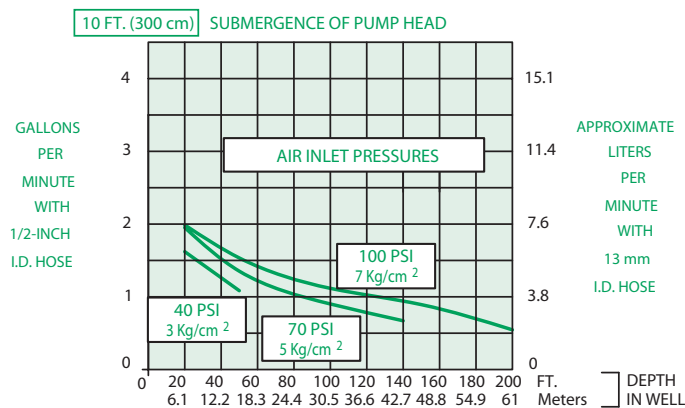
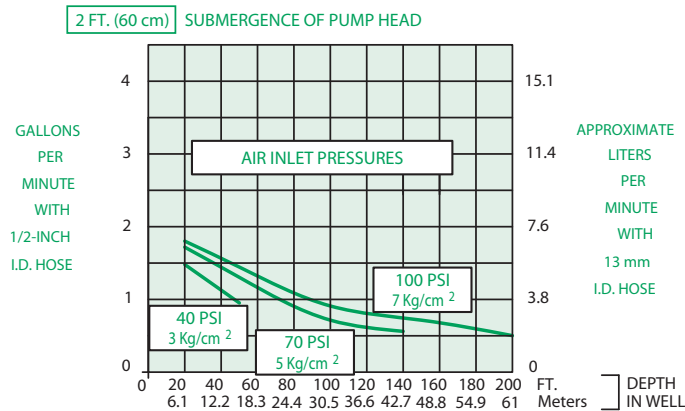
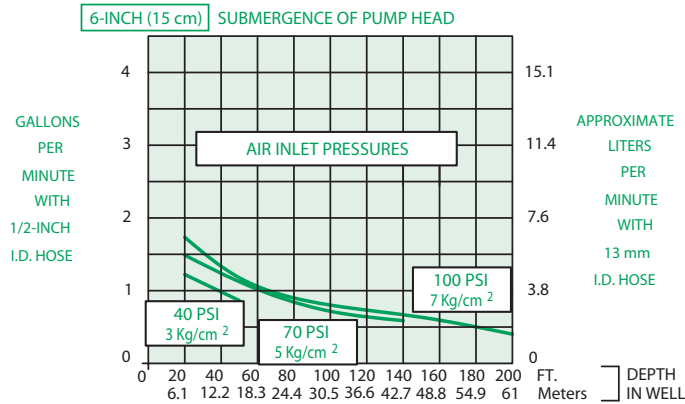

<sup>1</sup> FLOW RATES MAY VARY WITH SITE CONDITIONS. CALL QED FOR TECHNICAL ASSISTANCE.

### Air Consumption



STANDARD  
CUBIC FEET OF AIR  
PER  
GALLON PUMPED  
(SCF/GAL)

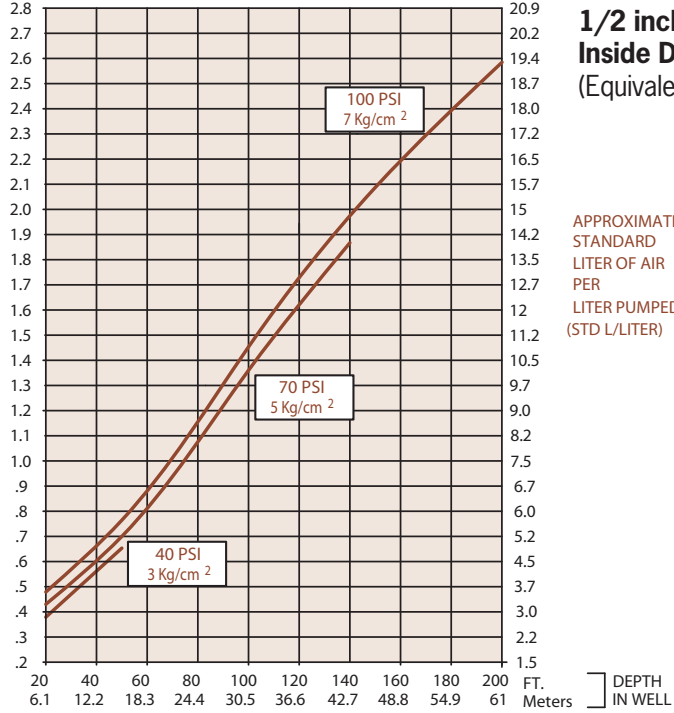

**1/2 inch (13 mm)  
Inside Diameter Discharge Hose**  
(Equivalent to 5/8-Inch O.D. Tubing)

APPROXIMATE  
STANDARD  
LITER OF AIR  
PER  
LITER PUMPED  
(STD L/LITER)

# AP2T

# AutoPump®

## Top Inlet, Long

**Max. Flow** 1.9 gpm (7.2 lpm)

**O.D.** 1.75 in. (4.45 cm)

**Length** 57 in. (144 cm)



### Description

The AP2 Top Inlet Long AutoPump provides maximum capabilities and flow in a top inlet pump for 2" (50 mm) diameter wells requiring an elevated inlet, such as pumping total fluids from wells contaminated with LNAPLs. It is offered in optional versions to handle even severe remediation and landfill pumping applications, and delivers flow rates up to 1.9 gpm (7.2 lpm). The AP2 Long Bottom Inlet AutoPump is complemented by the most comprehensive selection of accessories to provide a complete system to meet site-specific requirements. Call QED for prompt, no-obligation assistance on your pumping project needs.

### The AutoPump Heritage

The AP2 Top Inlet Long AutoPump is part of the famous AutoPump family of original automatic air-powered pumps, developed in the mid 1980s specifically to handle unique pumping needs at remediation and landfill sites. Over the years they've proven their durability at thousands of sites worldwide. AutoPumps are designed to handle difficult pumping challenges that other pumps can't, such as solvents, suspended solids, corrosives, temperature extremes, viscous fluids and frequent start/stop cycles. Beyond just the pump, AutoPump systems offer the most complete range of tubing, hose, connectors, caps and accessories to help your installation go smoothly. This superior pumping heritage, application experience and support back up every AutoPump you put to work on your project.

### Advantages

1. The original 2" automatic air-powered well pump, proven worldwide over 15 years
2. The industry leader in reliability, durability, flow rate and depth capability in an automatic pump for 2-inch wells
3. Handles solids, hydrocarbons, solvents, corrosive conditions, viscous fluids and landfill liquids
4. One-year warranty



### Pump Dimensions

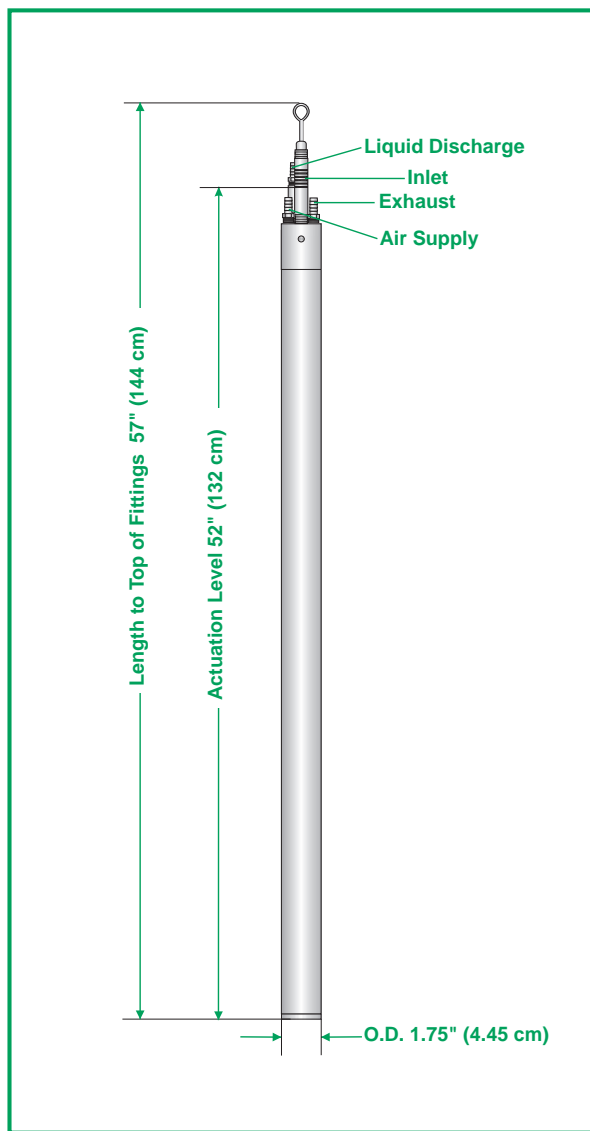

### Specifications & Operating Requirements

<b>Model</b>	<b>2" - Long AP2 Top Inlet</b>
<b>Liquid Inlet Location</b>	Top
<b>OD</b>	1.75 in. (4.45 cm)
<b>Length Overall (pump &amp; fittings)</b>	57 in. (144 cm)
<b>Weight</b>	7.8 lbs. (3.6 kg)
<b>Max. Flow Rate</b>	1.9 gpm (7.2 lpm) - See Flow Rate Chart
<b>Pump Volume / Cycle</b>	0.14 - 0.17 gal (0.53 - 0.64l)
<b>Max. Depth</b>	300 ft (91.4 m)
<b>Air Pressure Range</b>	5 - 130 psi (0.4 - 9.2 kg/cm <sup>2</sup> )
<b>Min. Actuation Level</b>	52 in. (132 cm)
<b>Air Usage</b>	0.38 - 1.57 scf / gal. (2.8 - 11.7 liters of air / fluid liter) - See Air Usage Chart
<b>Min. Liquid Density</b>	0.7 SpG (0.7 g/cm <sup>3</sup> )
<b>Standard Construction Materials<sup>1</sup></b>	
<b>Pump Body</b>	Stainless Steel
<b>Pump Ends</b>	Stainless Steel
<b>Internal Components</b>	Stainless Steel, Viton, PVDF <sup>3</sup>
<b>Tube &amp; Hose Fittings</b>	Brass or Stainless Steel
<b>Fitting Type</b>	Barbs or Quick Connects
<b>Tube &amp; Hose Options</b>	
<b>Tubing Material</b>	Nylon
<b>Sizes<sup>2</sup> - Liquid Discharge</b>	5/8 in. (16 mm) OD
<b>Pump Air Supply</b>	3/8 in. (9.5 mm) OD
<b>Air Exhaust</b>	1/2 in. (13 mm) OD
<b>Hose Material</b>	Nitrile
<b>Sizes - Liquid Discharge</b>	1/2 in. (13 mm) ID
<b>Pump Air Supply</b>	1/4 in. (6.4 mm) ID
<b>Air Exhaust</b>	3/8 in. (9.5 mm) ID

<sup>1</sup> Material upgrades available  
<sup>2</sup> Applies to QED supplied tubing; other tubing sources may not conform to QED fittings.

<sup>3</sup> PVDF - Polyvinylidene Fluoride

### Application Limits (base model)

Base model AP2 AutoPumps are designed to handle the application ranges described below. For applications outside this range, consult QED about AP2 upgrades.

Maximum Temperature: 150°F (65°C)

pH Range: 4-9

Solvents and Fuels: diesel, gasoline, JP1-JP6, #2 heating oils, BTEX, MTBE, landfill liquids

AP2 AutoPumps are warranted for one (1) year: 100% materials and workmanship.

### Flow Rates<sup>1</sup>

**1/2 inch (13 mm)  
Inside Diameter Discharge Hose**  
(Equivalent to 5/8-Inch O.D. Tubing)

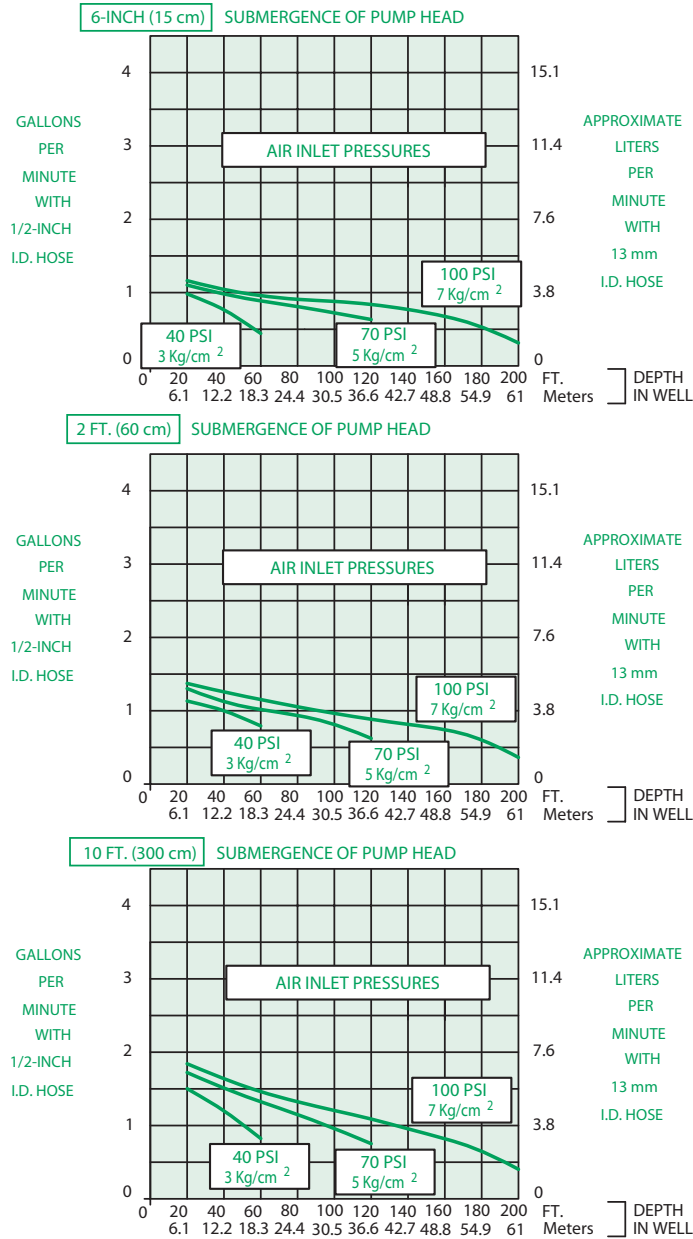

<sup>1</sup> FLOW RATES MAY VARY WITH SITE CONDITIONS. CALL QED FOR TECHNICAL ASSISTANCE.

### Air Consumption



STANDARD  
CUBIC FEET OF AIR  
PER  
GALLON PUMPED  
(SCF/GAL)

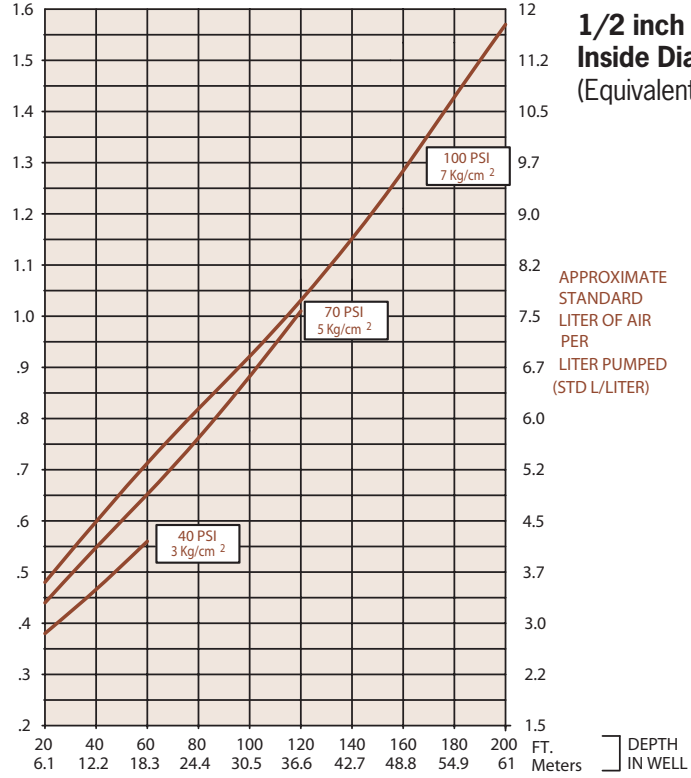

**1/2 inch (13 mm)  
Inside Diameter Discharge Hose**  
(Equivalent to 5/8-Inch O.D. Tubing)

APPROXIMATE  
STANDARD  
LITER OF AIR  
PER  
LITER PUMPED  
(STD L/LITER)

DEPTH  
IN WELL

**Max. Flow** 1.6 gpm (6 lpm)

**O.D.** 1.75 in. (4.45 cm)

**Length** 35 in. (89 cm)



### Description

The AP2 Top Inlet Short AutoPump provides maximum capabilities and flow in a top inlet pump for 2" (50 mm) diameter wells having shorter water columns and/or the need to pump down to lower water levels, compared to full-length pumps. It is designed for applications requiring an elevated inlet, such as pumping total fluids from wells contaminated with LNAPLs. It is offered in optional versions to handle even the most severe remediation and landfill pumping applications, and delivers flow rates up to 1.6 gpm (6 lpm). The AP2 Long Bottom Inlet AutoPump is complemented by the most comprehensive selection of accessories to provide a complete system to meet site-specific requirements. Call QED for prompt, no-obligation assistance on your pumping project needs.

### The AutoPump Heritage

The AP2 Top Inlet Short AutoPump is part of the famous AutoPump family of original automatic air-powered pumps, developed in the mid 1980s specifically to handle unique pumping needs at remediation and landfill sites. Over the years they've proven their durability at thousands of sites worldwide. AutoPumps are designed to handle difficult pumping challenges that other pumps can't, such as solvents, suspended solids, corrosives, temperature extremes, viscous fluids and frequent start/stop cycles. Beyond just the pump, AutoPump systems offer the most complete range of tubing, hose, connectors, caps and accessories to help your installation go smoothly. This superior pumping heritage, application experience and support back up every AutoPump you put to work on your project.

### Advantages

1. **The original 2" automatic air-powered well pump, proven worldwide over 15 years**
2. **The industry leader in reliability, durability, flow rate and depth capability in an automatic pump for 2-inch wells**
3. **Handles solids, hydrocarbons, solvents, corrosive conditions, viscous fluids and landfill liquids**
4. **One-year warranty**

### Pump Dimensions

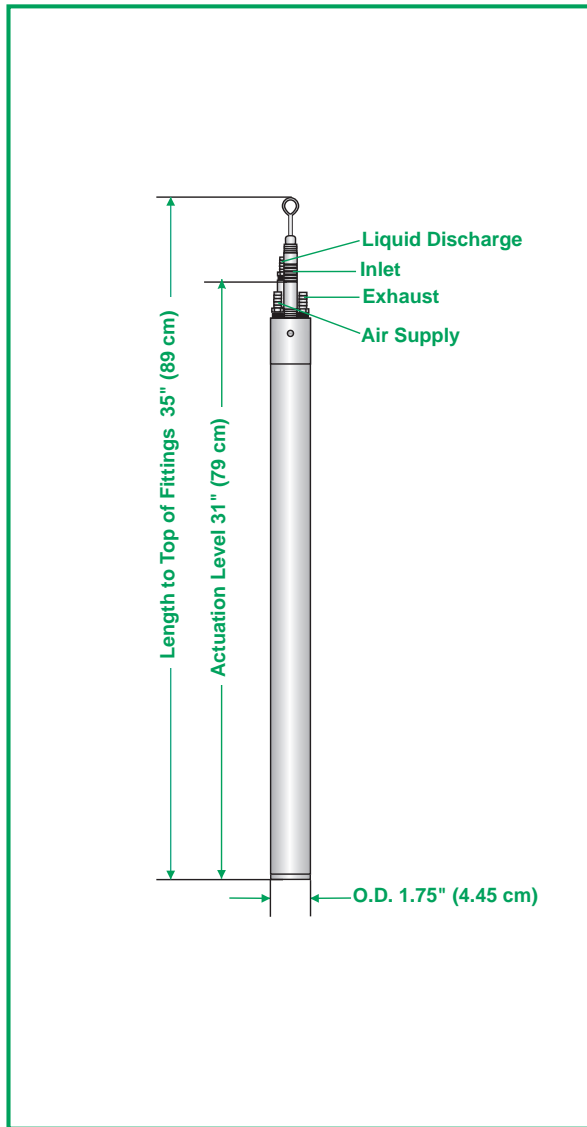

### Specifications & Operating Requirements

<b>Model</b>	<b>2" - Short AP2 Top Inlet</b>
<b>Liquid Inlet Location</b>	Top
<b>OD</b>	1.75 in. (4.45 cm)
<b>Length Overall (pump &amp; fittings)</b>	35 in. (89 cm)
<b>Weight</b>	5.7 lbs (2.6 kg)
<b>Max. Flow Rate</b>	1.6 gpm (6.0 lpm)
<b>Pump Volume / Cycle</b>	.05 - .08 gal (.19 - .30 l)
<b>Max. Depth</b>	300 ft (91.4 m)
<b>Air Pressure Range</b>	5 - 130 psi (0.4 - 9.2 kg/cm <sup>2</sup> )
<b>Min. Actuation Level</b>	31 in. (78.7 cm)
<b>Air Usage</b>	0.39 - 2.59 scf/gal (2.9 - 19.3 liters/fluid liter) See Air Usage Chart
<b>Min. Liquid Density</b>	0.7 SpG (0.7 g/cm <sup>3</sup> )
<b>Standard Construction Materials<sup>1</sup></b>	
<b>Pump Body</b>	Stainless Steel
<b>Pump Ends</b>	Stainless Steel
<b>Internal Components</b>	Stainless Steel, Viton, PVDF <sup>3</sup>
<b>Tube &amp; Hose Fittings</b>	Brass or Stainless Steel
<b>Fitting Type</b>	Barbs or Quick Connects
<b>Tube &amp; Hose Options</b>	
<b>Tubing Material</b>	Nylon
<b>Sizes<sup>2</sup> - Liquid Discharge</b>	5/8 in. (16 mm) OD
<b>Pump Air Supply</b>	3/8 in. (9.5 mm) OD
<b>Air Exhaust</b>	1/2 in. (13 mm) OD
<b>Hose Material</b>	Nitrile
<b>Sizes - Liquid Discharge</b>	1/2 in. (13 mm) ID
<b>Pump Air Supply</b>	1/4 in. (6.4 mm) ID
<b>Air Exhaust</b>	3/8 in. (9.5 mm) ID

<sup>1</sup> Material upgrades available  
<sup>2</sup> Applies to QED supplied tubing;  
 other tubing sources may not  
 conform to QED fittings.

<sup>3</sup> PVDF - Polyvinylidene Fluoride

### Application Limits (base model)

Base model AP2 AutoPumps are designed to handle the application ranges described below. For applications outside this range, consult QED about AP2 upgrades.

Maximum Temperature: 150°F (65°C)

pH Range: 4-9

Solvents and Fuels: diesel, gasoline, JP1-JP6,  
 #2 heating oils, BTEX, MTBE, landfill liquids

AP2 AutoPumps are warranted for one (1) year:  
 100% materials and workmanship.

### Flow Rates<sup>1</sup>

**1/2 inch (13 mm)  
Inside Diameter Discharge Hose**  
(Equivalent to 5/8-Inch O.D. Tubing)

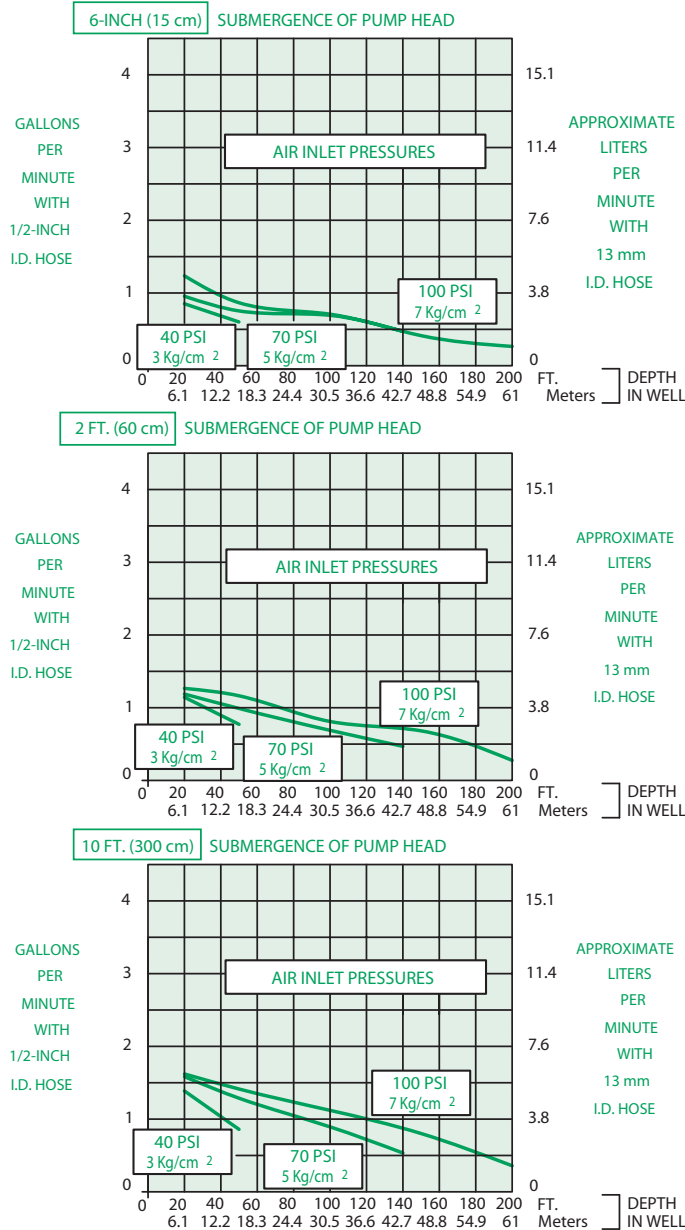

<sup>1</sup> FLOW RATES MAY VARY WITH SITE CONDITIONS. CALL QED FOR TECHNICAL ASSISTANCE.

### Air Consumption



STANDARD  
CUBIC FEET OF AIR  
PER  
GALLON PUMPED  
(SCF/GAL)

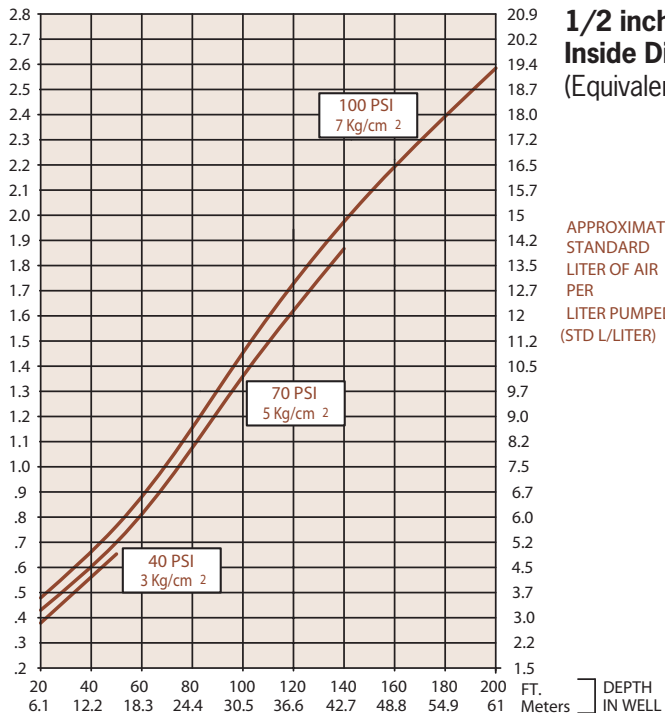

**1/2 inch (13 mm)  
Inside Diameter Discharge Hose**  
(Equivalent to 5/8-Inch O.D. Tubing)

APPROXIMATE  
STANDARD  
LITER OF AIR  
PER  
LITER PUMPED  
(STD L/LITER)

DEPTH  
IN WELL

## Tubing & Hose



Model	Type	Material	Liquid Discharge Size	Air Supply Size	Exhaust Size	Maximum Pressure	Maximum Depth	Minimum Bend Radius
<b>HIFLOTUBE</b>	Jacketed 3-Tube set	Nylon 12	1.25" OD (32 mm)	1/2" OD (13 mm)	5/8"OD (16 mm)	200 PSI (14 kg/cm <sup>2</sup> )	400 feet (122 m)	8" (20 cm)
<b>STDTUBE</b>	Jacketed 3-Tube set	Nylon 12	1" OD (25.4 mm)	1/2" OD (13 mm)	5/8"OD (16 mm)	200 PSI (14 kg/cm <sup>2</sup> )	400 feet (122 m)	7" (18 cm)
<b>AP2TUBE</b>	3-Tube set	Nylon 12	5/8" OD (16 mm)	3/8"OD (9.5 mm)	1/2"OD (13 mm)	200 PSI (14 kg/cm <sup>2</sup> )	400 feet (122 m)	2.5" (6.5 cm)
<b>HIPSIHOSE</b>	3-hose set	Nitrile	1" ID (25.4 mm)	3/8"ID (9.5 mm)	1/2"OD (13 mm)	300 PSI (21 kg/cm <sup>2</sup> )	600 feet (183 m)	8" (20 cm)
<b>HIFLOHOSE</b>	3-hose set	Nitrile	1" ID (25.4 mm)	3/8"ID (9.5 mm)	1/2"OD (13 mm)	100 PSI (7 kg/cm <sup>2</sup> )	200 feet (61 m)	8" (20 cm)
<b>STDHOSE</b>	3-hose set	Nitrile	3/4" ID (13 mm)	3/8"ID (9.5 mm)	1/2"OD (13 mm)	300 PSI (21 kg/cm <sup>2</sup> )	600 feet (183 m)	7" (18 cm)
<b>AP2HOSE</b>	3-hose set	Nitrile	1/2" ID (13 mm)	1/4"ID (6 mm)	3/8"ID (9.5 mm)	300 PSI (21 kg/cm <sup>2</sup> )	600 feet (183 m)	5" (13 cm)

QED offers the choice of jacketed nylon tubing or hose sets for downwell use, and single tubes and hoses for surface runs to fit each project's needs. The jacketed nylon tubing is an exclusive developed by QED that encloses all of the nylon tubes inside a strippable nylon outer cover, a convenient package designed to provide lighter weight, increased chemical resistance, smoother handling and a smaller profile in the well. For applications where the tighter bend radius of hose is preferred, hose sets are offered in several sizes. Other hose and tube materials are available for special applications.

The choice of hose and tube connection fittings used on pumps, caps and other components can make an important difference in the ease and quality of installation and service on your project. That's why QED offers a variety of connecting fitting types and materials, including quick-connects in both brass and stainless steel.

Note: All QED tube, hose and fitting combinations are engineered specifically to provide user safety, high pullout strength, ease of installation, and leak tight connections for maximum assurance that the pumping system goes in right and stays trouble-free. It is especially important that the mating diameters and the tolerances of fittings, tubes and hoses be carefully controlled to ensure a fit that is snug yet doesn't damage the hose or tube due to excessive stretching. Don't trust your project to general purpose tubing, hose, and fittings that weren't specifically designed to work together.

### Advantages

- All dimensions of QED tube, hose and fittings are carefully designed and controlled to ensure high flow capacity, easy assembly, high pullout strength and leak-tight connections
- Innovative jacketed nylon tubing is highly regarded by experienced users for its light weight, smooth profile and ease of handling
- QED offers an unmatched range of connector fitting options to make installation and maintenance easier and more efficient



## AutoPump Well Caps

Vacuum seal well cap with brass quick connects, filter regulator and pump cycle counter

Hundreds of wellhead cap and flange combinations are available from QED on a standard and custom basis to fit site needs and ease installation and maintenance. The table below lists some of our most commonly chosen wellhead assemblies. Our assemblies are based on the know-how gained through our 20 years experience and thousands of installations. Besides connecting to the pump tubing or hose, wellhead assemblies have to be designed for safety, equipment support strength, pump level adjustment, access for data and sample collection, and durability. Call us for more detailed information.

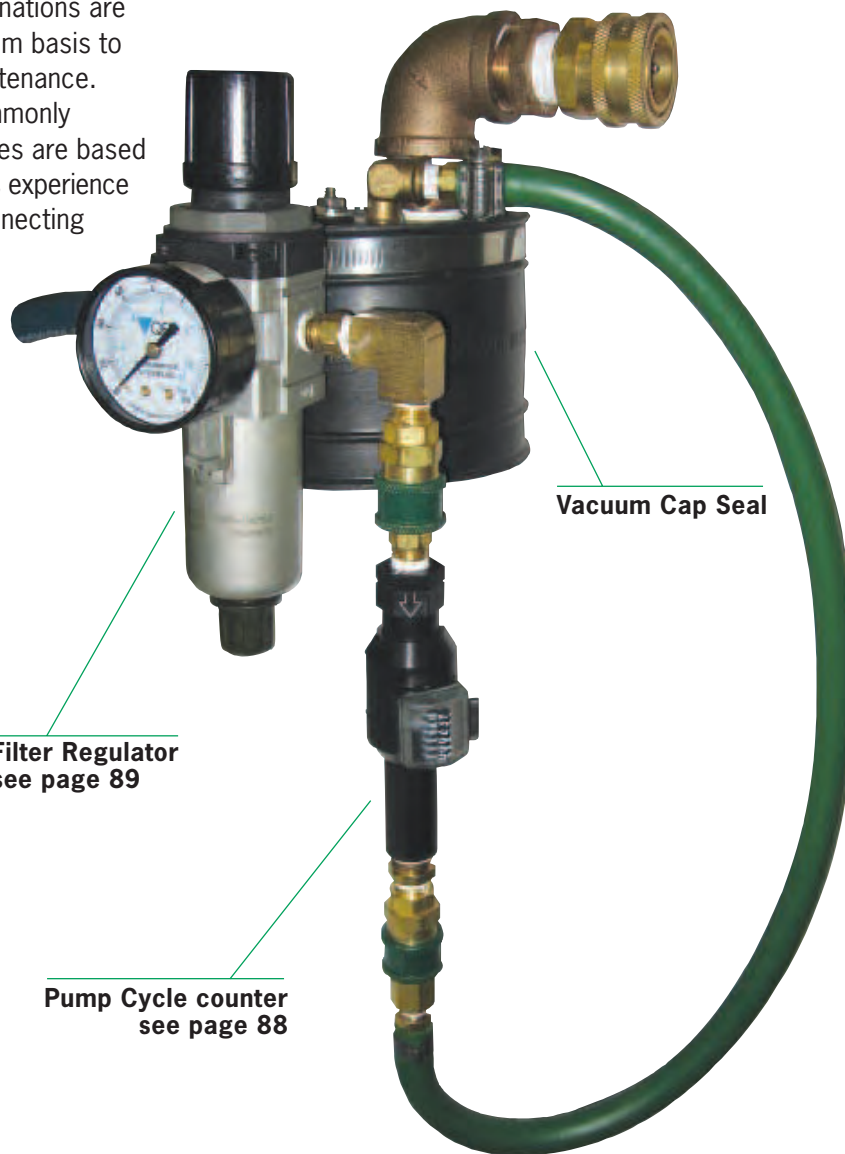

Quick connect fitting available in brass or stainless steel



Custom flange



Compression fitting for pass-through hose or tubing. Available in nylon

Filter Regulator see page 89

Pump Cycle counter see page 88

Vacuum Cap Seal

Wellhead Assembly	Description	Fitting Types (hose & tubing)	Fitting Materials	Well Diameters
<b>Open-hole cap</b>	Non-sealing cap with open pass-through holes for hoses; allows easy pump height adjustment with support rope/cable	No fittings		2", 4", 6", custom (50, 100, 150 mm)
<b>Slip</b>	Non-sealing cap with fittings for connection to air supply and liquid discharge lines	quick-connects, compression fittings	Brass, SS, poly	2", 4", 6", custom (50, 100, 150 mm)
<b>Vacuum Seal</b>	Sealing cap with fittings for connection to air supply and liquid discharge lines	quick-connects, compression fittings	Brass, SS, poly	2", 4", 6", custom (50, 100, 150 mm)
<b>Flange</b>	Sealing flange with fittings for connection to air supply and liquid discharge lines	quick-connects, compression fittings	Brass, SS, poly	Custom

## Flow Counters

### Cycle Counter

The Cycle Counter detects and displays each AutoPump cycle via the pulse of air that occurs in the supply line. Since the liquid volume delivered by each pump cycle is relatively consistent for a given well condition, the total liquid volume delivered can be monitored with these cycle counts. An important advantage of the Cycle Counter method is its long-term reliability and low maintenance, since it requires no contact with the pumped fluid and no extra components in the liquid flow path. Cycle Counters can also be ordered with an electronic pulse output to support automated flow data collection.



### Cycle Counter Specifications

**Type:** Magnetic piston/spring

**Readout:** Direct digital (remote option), non-resettable

**Maximum Pressure:** 200 psi (14 kg/cm<sup>2</sup>)

**End options:** NPT, barb, quick connect

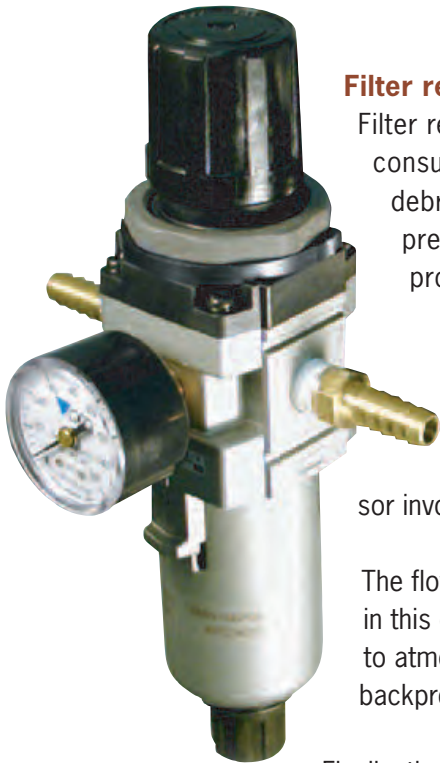

### Filter regulators

Filter regulators are recommended for each pump at the wellhead to economize on system air consumption, allow control of pump flow rate, and reduce service needs caused by air system debris and contaminants. These high quality filter regulators are coated on the inside to prevent corrosion from condensed moisture. All QED well caps and flanges include mounting provisions for these filter regulators, and other mounting options are available.

### Compressor Sizing

A compressed air supply is required to power AutoPumps. Estimation of the fluid flow rates and air consumption of the AutoPumps and sizing the fluid lines, air lines, and air compressor involves a number of factors. Our application specialists are ready to assist you.

The flow rates and air consumption for the AutoPumps can be compared by using the charts provided in this catalog for each model. The flow rate and air use curves in this catalog are based on pumping to atmospheric pressure at the wellhead, and do not take into account any liquid piping system backpressures due to elevation changes or fluid friction.

Finally, there are some initial guidelines for air compressors. Most importantly, follow all application guidelines of the compressor manufacturer. A piston compressor may be a start / stop type or a constant run type. The tank (receiver) must be large enough, particularly for the start / stop type. The motor should not turn on more times an hour than recommended by the manufacturer. And start/stop compressors are typically assigned a 50% maximum duty cycle, meaning that the compressor is sized to provide twice the maximum air demand of the entire AutoPump system.

Rotary screw compressors are designed for constant operation, and so are sized to just slightly exceed the maximum air supply requirement; it is recommended that rotary screw compressors not be grossly oversized because some types may be damaged by continued operation at low partial capacity.

## Tank Full Shutoffs

### Dual-Sensor Tank-Full Shut-Off (TFSO) System

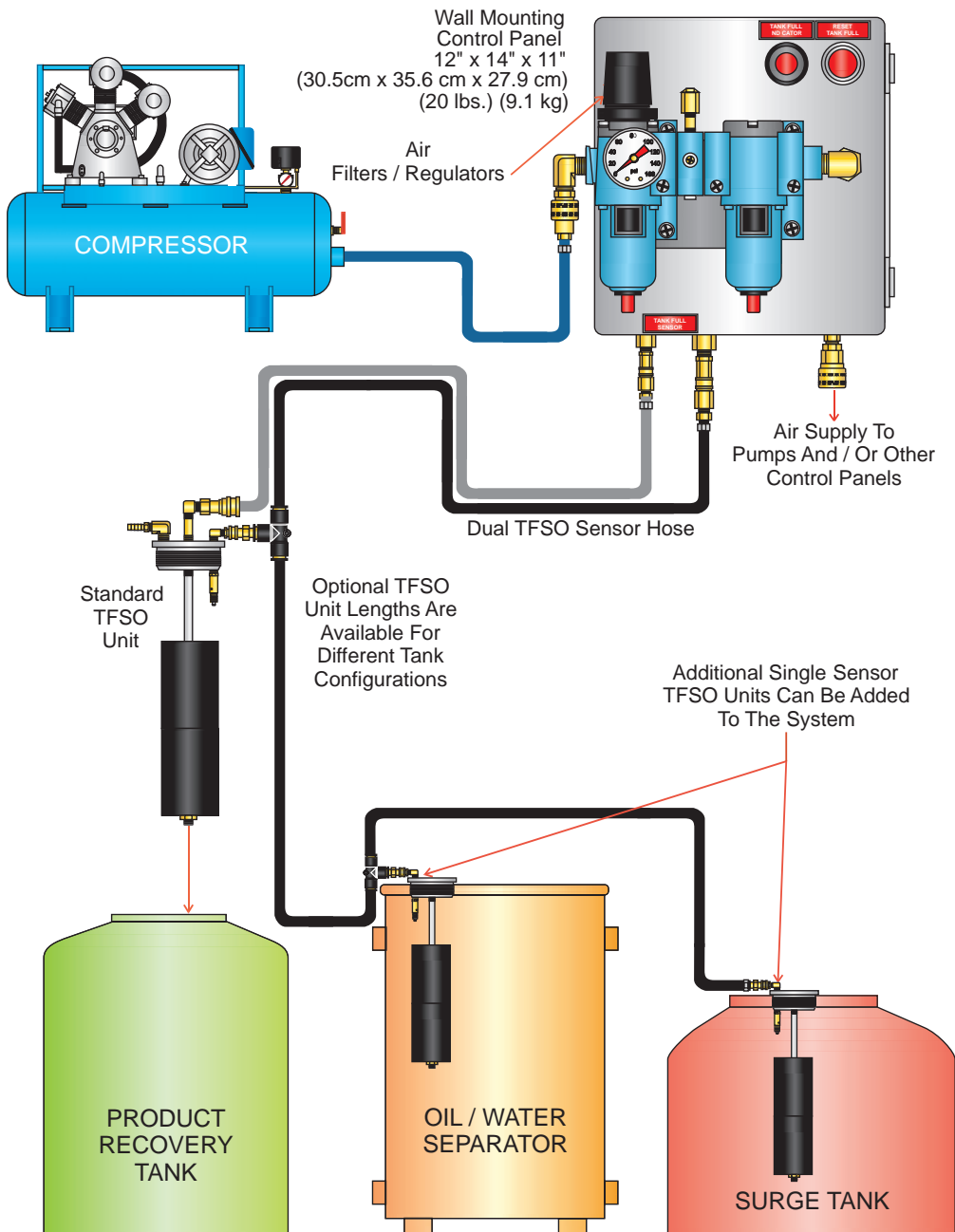

QED's Tank-Full Shutoff senses when your recovery tank is full and automatically shuts off the pump air supply. It is all pneumatic for safety, and includes two independent level detection methods for failsafe operation. The Tank-Full Shutoff threads into standard 2" NPT fittings on drums and tanks.

#### Tank Full Shutoff Specifications:

**Power Supply:** Fully pneumatic

**Level Sensor Type:** Dual; Bubbler tube and float switch

**Air Usage:** 0.7 scfm @ 80 psi (19.8 lpm @ 5.6 kg/cm<sup>2</sup>)

**Tank Connection:** 2-inch male NPT

## Application Data Sheet



### Site Information Form

**QED USE ONLY**

Today's Date \_\_\_\_\_  
Quote Number \_\_\_\_\_  
Sales Order Number \_\_\_\_\_

#### CUSTOMER INFORMATION

Name: \_\_\_\_\_ Title: \_\_\_\_\_  
Company: \_\_\_\_\_  
Address: \_\_\_\_\_  
Email: \_\_\_\_\_  
Phone: \_\_\_\_\_ FAX: \_\_\_\_\_

#### SITE INFORMATION

Site Name: \_\_\_\_\_  
Project Ref: \_\_\_\_\_  
Company: \_\_\_\_\_  
Address: \_\_\_\_\_  
Phone: \_\_\_\_\_ FAX: \_\_\_\_\_

#### SENSORS REQUIRED

- Tank-Full Shut-Off     Fluid Level  
 High-Water Shut-Off     Pump Cycle Counter

#### APPLICATION TYPE

- Total Fluids     Dual Pump     Condensate  
 DNAPL     LNAPL     Leachate

#### APPLICATION DESCRIPTION

Pumping Objectives (attach additional information and diagrams).

Properties of pumped fluids contaminants/viscosity/concentrations/pH/temperature/specific gravity/TDS (attach additional information . )

Please attach sketch of site, well and equipment layout.

#### WELL DATA

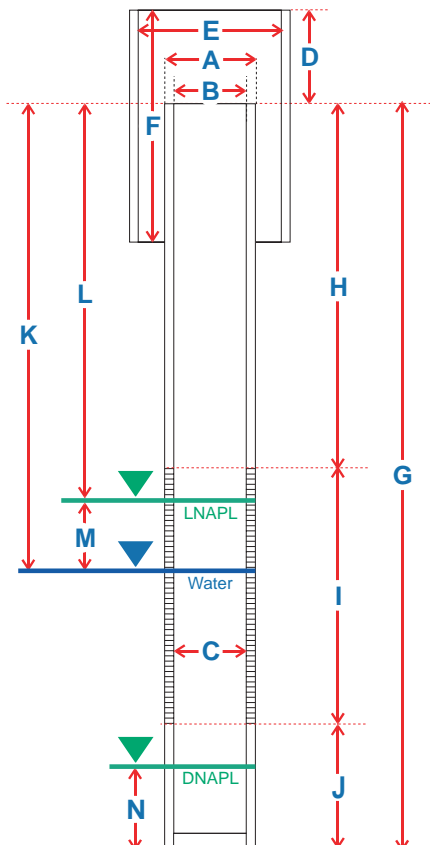

Note: Please note any special characteristic on illustration above

WELL IDENTIFICATION NUMBER					
A	Well casing OD				
B	Well casing ID at wellhead				
C	Well casing ID at location of equipment				
D	Well casing to top of outer / vault casing				
E	Vault Dimensions				
F	Vault Depth				
G	Depth to bottom of the well				
H	Depth to top of screen				
I	Depth to bottom of the screen				
J	Sump length				
K	Depth to static water level				
L	Depth to top of LNAPL layer (if present)				
M	LNAPL thickness (if present)				
N	DNAPL thickness (if present)				
	Desired fluid pumping rate				
	Final drawdown level				
	LNAPL removal rate (if present)				
	Water / Leachate removal rate				
	DNAPL removal rate (if present)				
	Maximum daily water table fluctuation				
	Casing Materials				
	Well angle off vertical (% or degrees)				
	Exhausting inside or outside the well				
	Well under vacuum (Hg or H2O)				
	Any known material degradation (yes/no)				

The information provided on this form will be kept confidential by QED.

### QED AutoPump Warranty Period Summary

Following is a summary of the warranty periods only for QED AutoPumps and accessories; **this IS NOT the complete warranty**. Contact QED for a copy of the complete warranty

**1. AP4+ AutoPumps (Long and Short lengths; Top and Bottom Inlets)**

warranted for five (5) years: 100% materials and workmanship.

Low-Drawdown AutoPumps are warranted for one (1) year: 100% materials and workmanship.

**2. AP3 AutoPumps (Long and Short lengths; Top and Bottom Inlets)**

warranted for two (2) years: 100% materials and workmanship.

**3. AP2 AutoPumps (Long and Short lengths; Top and Bottom Inlets)**

warranted for one (1) year: 100% materials and workmanship.

**4. Hoses, Tubing, Fittings, Well Caps and Flanges**

warranted for one (1) year: 100% materials and workmanship.

There will be no warranty for application or material compatibility.

**5. Pneumatic Data Modules / Logic Control Panels**

warranted for one (1) year: 100% materials and workmanship.

**6. Parts and Repairs**

warranted for ninety (90) days: 100% materials and workmanship; when repairs are performed by QED or its appointed agent; from date of repair or for the full term of the original warranty, whichever is longer. Separately sold parts are warranted for ninety (90) days: 100% materials and workmanship.



**Envirotecnicos Global Service SL**

**Oficinas y Fabricación:** Calle dels Pirineus s/n (esquina Espinau)

17460 - Celrà - Girona Tel: 872 080 542 Fax: 872 080 543

**Delegación Madrid:** Avda. de Castilla 28 - 28830 - Tel: 916 780 039

Servicio al cliente: [envirotecnicos@envirotecnicos.com](mailto:envirotecnicos@envirotecnicos.com)

[www.envirotecnicos.com](http://www.envirotecnicos.com)

